

WELCOME

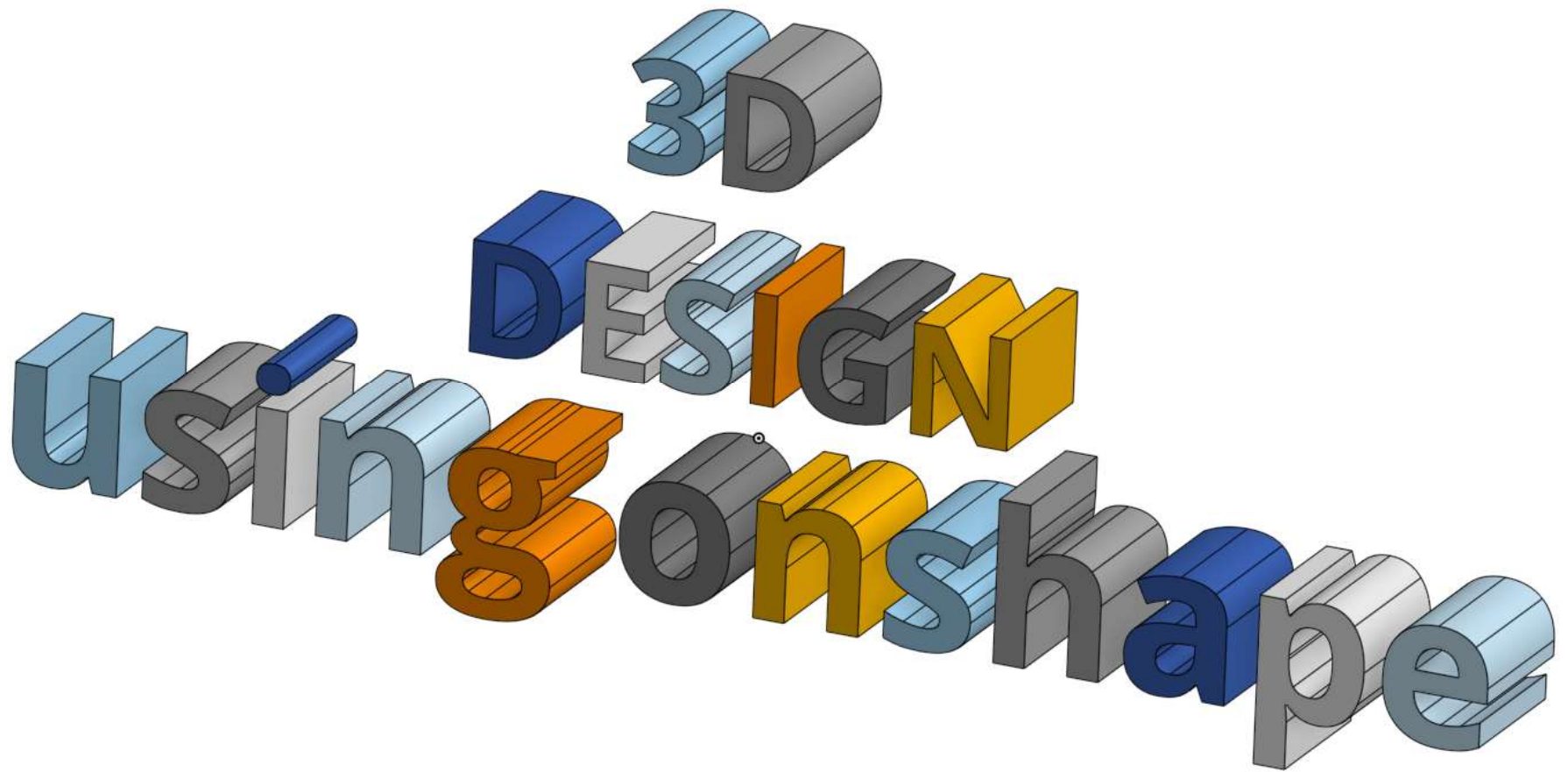



Onshape Bootcamp

The fastest way for experienced CAD professionals to get up and running with Onshape and Agile Product Design. This course dives into the major differences between full-cloud Onshape and traditional file-based CAD.

Select session to enroll

Feb 1-4 (2:00-4:30pm)

\$500.00

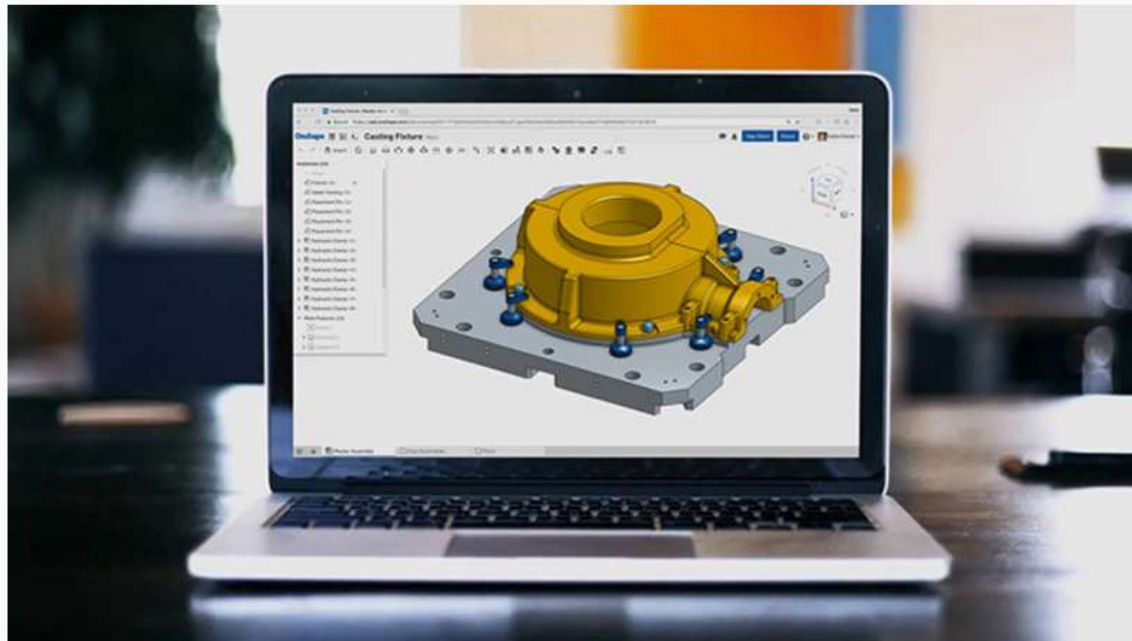

Course Description

What is Instructor-Led Training?

Instructors

Meetings

E3-Club 2021

Onshape Bootcamp is designed especially for new Onshape users who want a quick crash course to learn

1. Introduction

1. Navigation

2. Select/Zoom/Spin/Pan/ View Cube

3. Options in/mm

4. Plane Selection/Sketch → Extrude

5. Feature Tree

6. Variables

2. Extrude/Revolve/Sweep

- **Axis signpost**
- **Planes**
- **Origin**

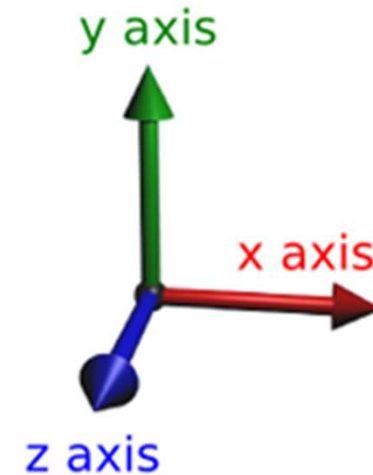



WELCOME

If you are interested in 3D printing with Ender 3 then you are in the right place!! This club is organized to share ideas and techniques and heartaches about getting good prints with the Ender 3.

If you would like to join just use the register in the menu or [click here](#) to sign up.

There is no cost to be a member and generally we have meetings on a monthly basis with various technical topics infused with a pizza party.

Once you register you will have access to our online knowledge-base and can interact with the members via forums and messaging.



TPM

Log Out

NEXT MEETING

February 5, 2021
Friday, 12noon-2pm
Topic: Powder Printing

3D Design

3D Onshape Classroom

3D Classroom

Alignment Exercise

Box Exercise

GearPin Code Block

Day3RRtrack

3DDBtrack

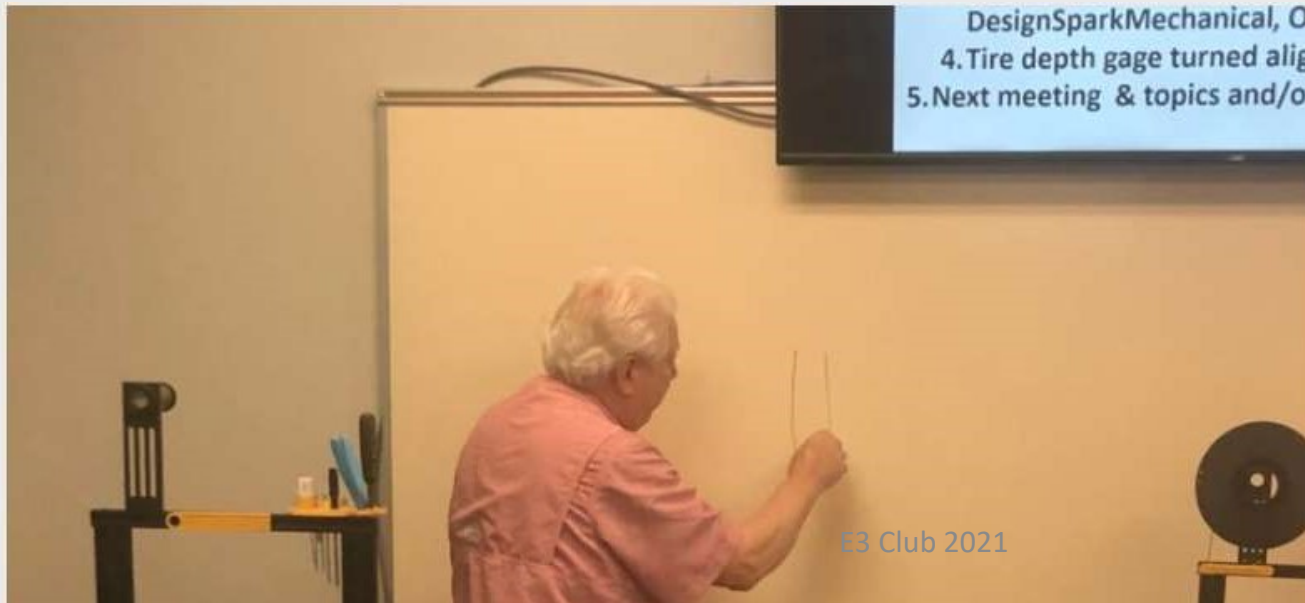

E3 Club 2021



m/signin

(73) Chris Brunelle -... VXB.com Ball Beari... 404 Functions For Cell C... Personal Finance Cl... CBI TLawnR Color Functions In... CMRR Na



makerXX@cbimakerspace.com

.....

Sign in

[Forgot your password?](#)

[Onshape Terms](#)

[Don't have an account? Sign up](#)



User: makerXX@cbimakerspace.com

Password: MaKeR2569^^

03 Aug 2021

10:00 WarmUp – quiz

10:05 quick keyring → download

10:30 Domino

10:55 Break

11:00 revisit Tracks

Fancy Rail

Scale

Parameters

12:15 Lunch

1:15 Quiz

1:20 Oil Tank

2:40 Quiz

3:00 Adjourn

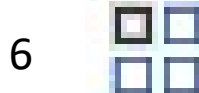

___ A. COINCIDENT

___ B. CONSTRUCTION LINE TOGGLE

___ C. PRACTICE

___ D. TRIM TOOL

___ E. VERTICAL

___ F. HORIZONTAL

___ G. TANGENT

___ H. MIRROR

___ I. PATTERN

___ J. DIMENSION

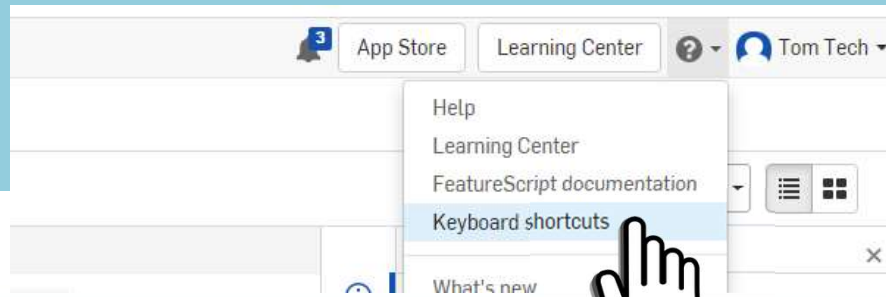

General	Part Studio	Sketch	Drawings
General	Part Studio	Sketch	Drawings
shift ? Keyboard shortcuts	shift s Sketch	shift Suppress inferencing	shift z Zoom in
ctrl / ⌘ z Undo	shift e Extrude	i Line	z Zoom out
ctrl y ⌘ shift y Redo	shift f Fillet	g Corner rectangle	f Zoom to fit
delete Delete selection	ctrl m Mate connector	r Center point rectangle	w Zoom to window
space bar Clear selection	shift Lock mate inference	c Center point circle	p Projected view
. Select other	a Flip primary axis	a 3 point arc	d Dimension
shift n Rename selection	q Reorient secondary axis	shift f Fillet	m Maximum/minimum dimension
esc Cancel command	k Hide/show mate connectors	m Trim	shift r Radial dimension
enter Accept command	3D view	x Extend	shift d Diameter dimension
shift enter Accept & repeat command	shift z Zoom in	o Offset	shift q Quad & Mid snap points
alt c Search tools	z Zoom out	u Use	n Note
s Shortcut toolbars	f Zoom to fit	d Dimension	ctrl q Update drawing
shift click Open in new window	w Zoom to window	i Coincident	i Line
ctrl / ⌘ click Open in new tab	← → ↑ ↓ Rotate	b Parallel	ctrl s Display sheet menu
ctrl u Feedback/Report a bug	shift ← → ↑ ↓ Precision rotate	t Tangent	pg dn Next sheet
alt t Search tabs	ctrl shift ← → ↑ ↓ Pan	h Horizontal	pg up Previous sheet
ctrl space bar Quick tab switching	shift 1 Front view	v Vertical	home First sheet
Assembly	shift 2 Back view	e Equal	end Last sheet
shift Lock mate inference	shift 3 Left view	q Toggle construction	alt LMB drag Copy annotation
ctrl / ⌘ c Copy	shift 4 Right view		
ctrl / ⌘ v Paste	shift 5 Top view		
m Mate	shift 6 Bottom view		
ctrl m Mate connector	shift 7 Isometric view		
i Insert dialog	n View normal to		
shift s Snap mode	p Hide/show planes		
h Show mates mode	shift p Hide all construction		
a Flip primary axis	shift v Named views		
q Reorient secondary axis	shift x Section view		
j Hide/show mates	y Hide selected part		
k Hide/show mate connectors	shift y Show selected part		
	shift t Make transparent		
	shift i Isolate		



learn.onshape.com/catalog?labels=%5B%22Learning%20Pathways%22%5D&values=%5B%22All%22%5D



MY DASHBOARD BASKET (0)

Browse

Search for content Sort by

- > Instructor-Led Trainings
- > Learning Pathways
 - All
 - CAD Basics
 - Onshape Fundamentals
 - Part Studios
 - Configurations
 - Educator Resources
- > Self-Paced Courses
- > Technical Briefings
- > Videos
- > Certification

FUNDAMENTALS

Onshape Fundamentals: CAD

Learning Pathway
Learn fundamental CAD concepts specific to Onshape.

[Start Learning Path](#)

BASICS

CAD Basics

Learning Pathway
Explore key concepts involved in modeling parts and assemblies in a feature...

[Continue Learning Path](#)

EDU ENTERPRISE

Onshape Enterprise for Educators

Educator Resource
Learn how to configure enterprise settings for your account and explore res...

[View Details](#)

PART STUDIOS

Advanced Part and Surfacing Design

Learning Pathway
Explore advanced part and surfacing modeling techniques.

[View Details](#)

FUNDAMENTALS

Onshape Fundamentals: Data Management

Learning Pathway
Learn fundamental data management concepts specific to Onshape.

[Start Learning Path](#)

CONFIGURATIONS

Onshape Configurations

Learning Pathway
Configure parts with Onshape's powerful configuration input tables.

[View Details](#)

200x200 (1).stl



3DDOS_RRtracks Main  0  0  0

  App Store

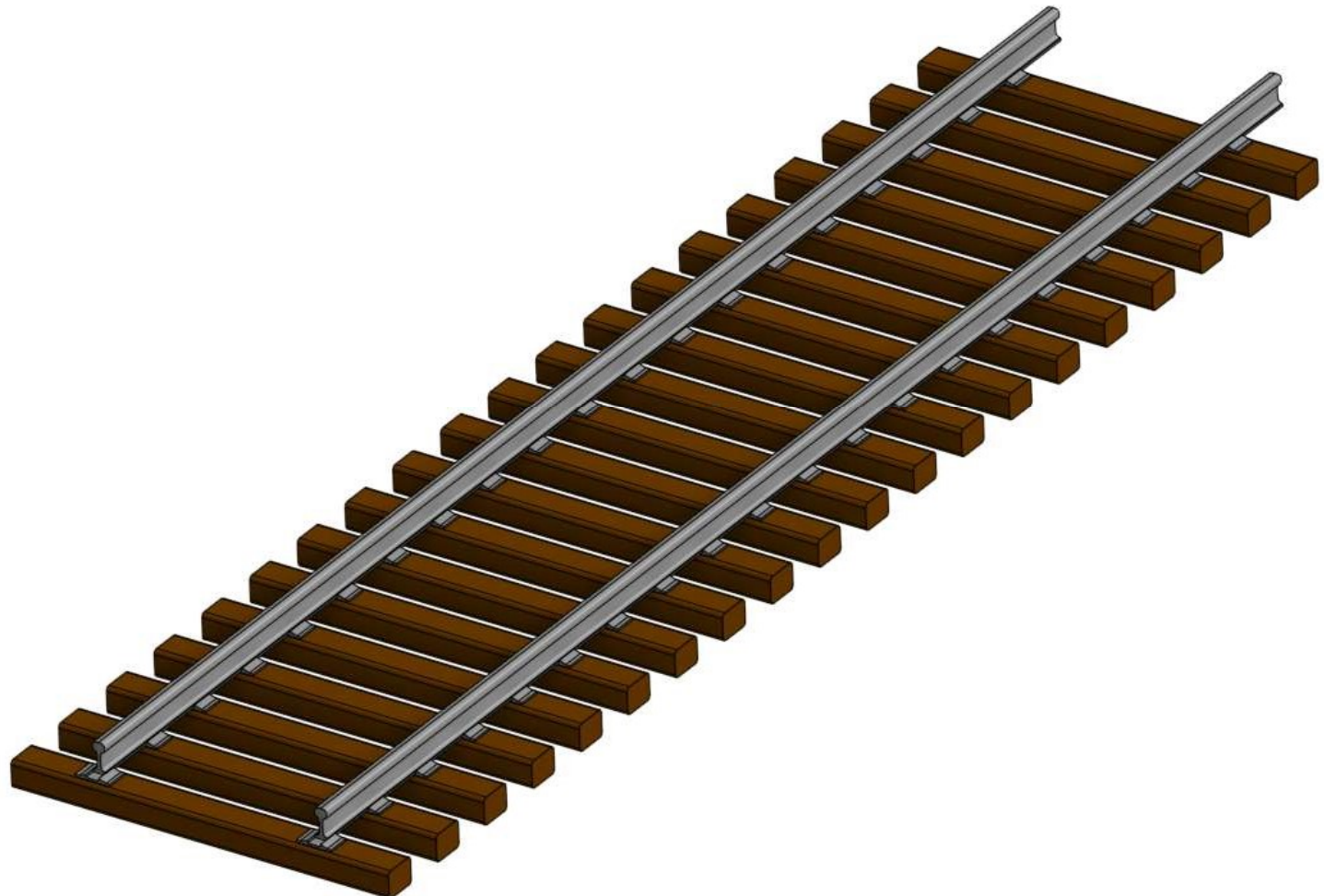



Create new sketch (Shift-s)
Create a new sketch on the selected plane, planar face, or mate connector. A sketch is the basis for all parts and must be created in order to use Extrude or other feature tools.

1. Select a plane, planar face, or mate connector.
2. Select a sketch tool (line, rectangle, etc).
3. Create sketch curves.
4. Click the green checkmark to save or the red x to cancel.

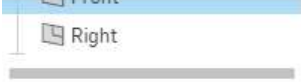

PRACTICE

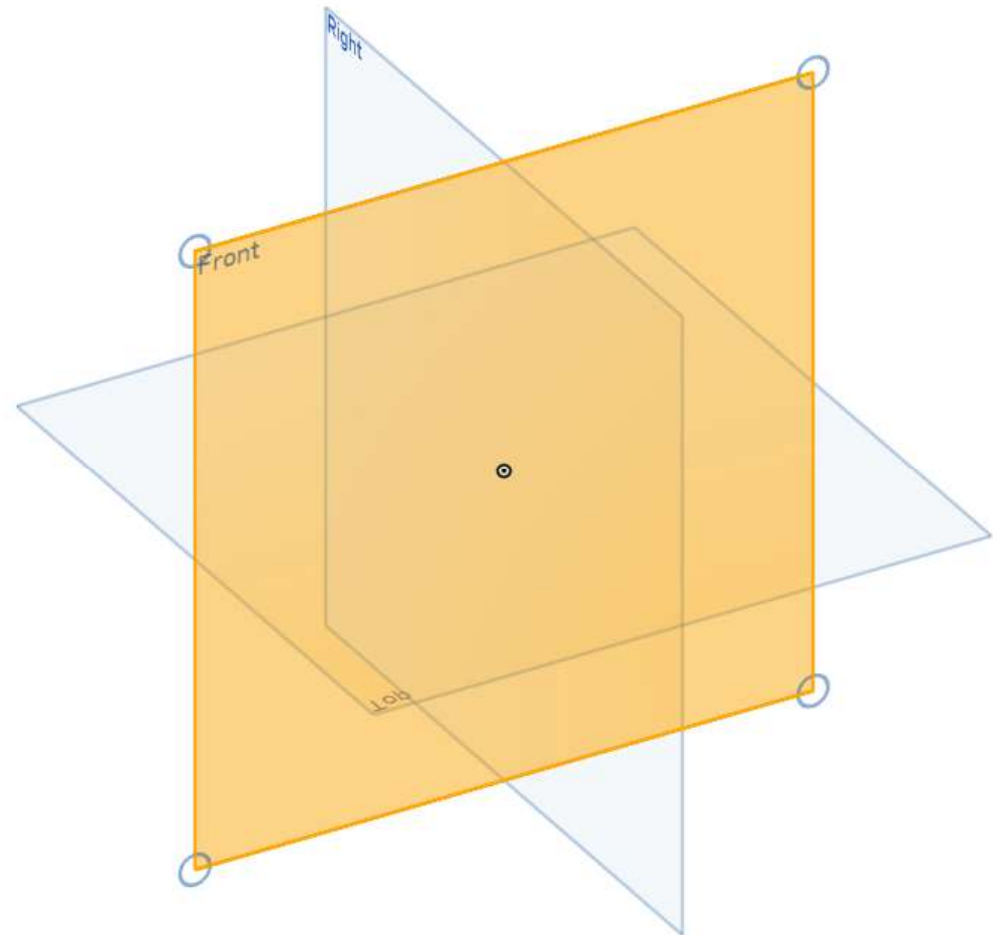

**Select Right Plane
Select Sketch**

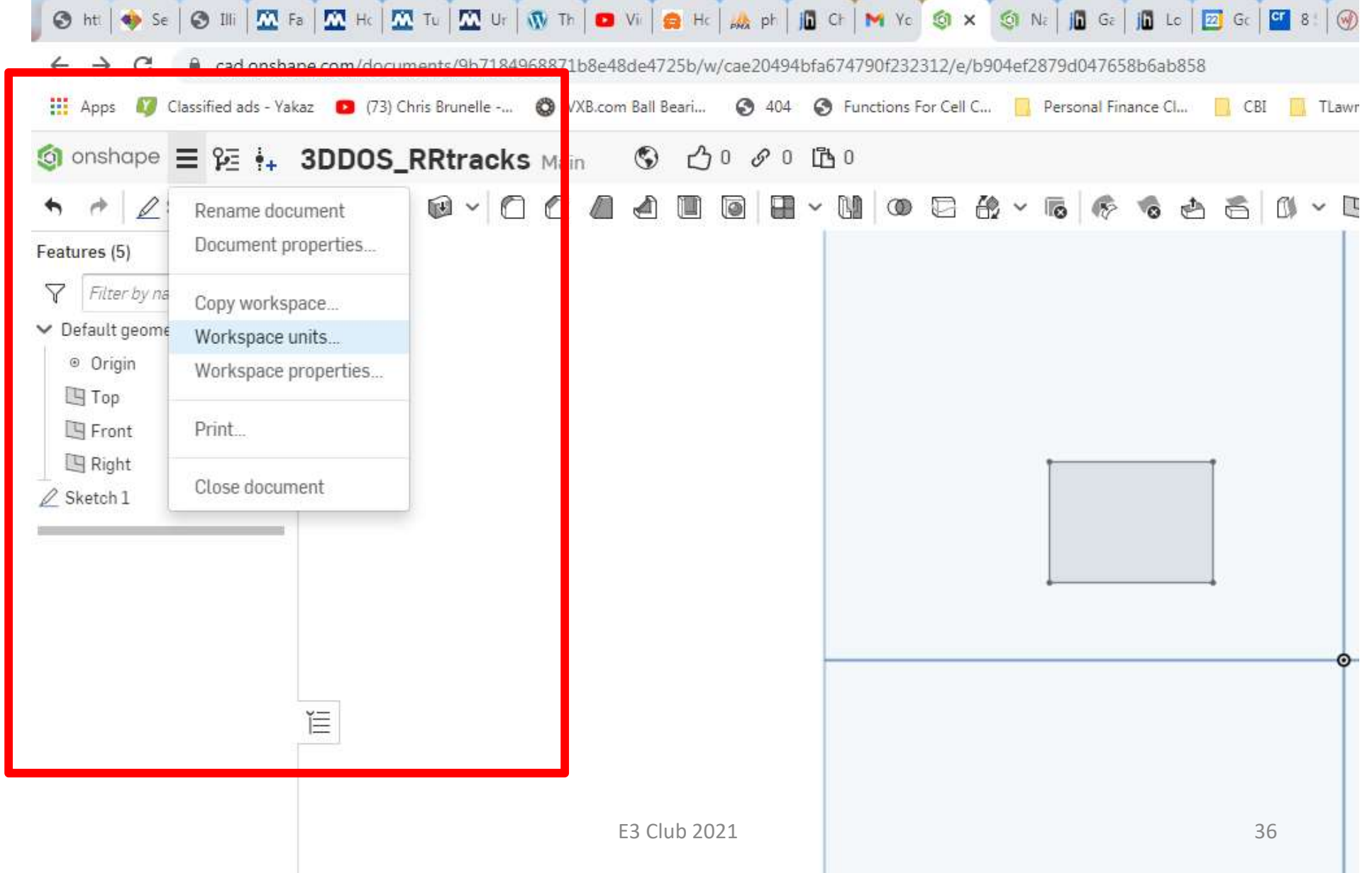

The screenshot shows the Onshape web interface. A red rectangular box highlights the left-hand sidebar and the top toolbar. In the sidebar, the 'Features (5)' section is expanded, and the 'Default geometry' section is visible, showing 'Origin', 'Top', 'Front', 'Right', and 'Sketch 1'. The 'Workspace units...' option is highlighted in blue. The main workspace area shows a 3D model of a rectangular block on a light blue background. The bottom of the page contains the text 'E3 Club 2021' on the left and '36' on the right.

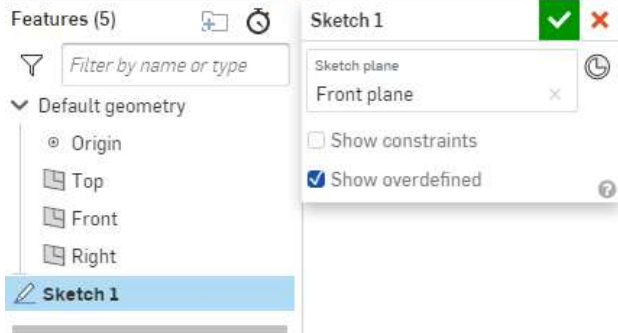

Reduced rendering performance detected. [Check system compatibility in a new tab](#)

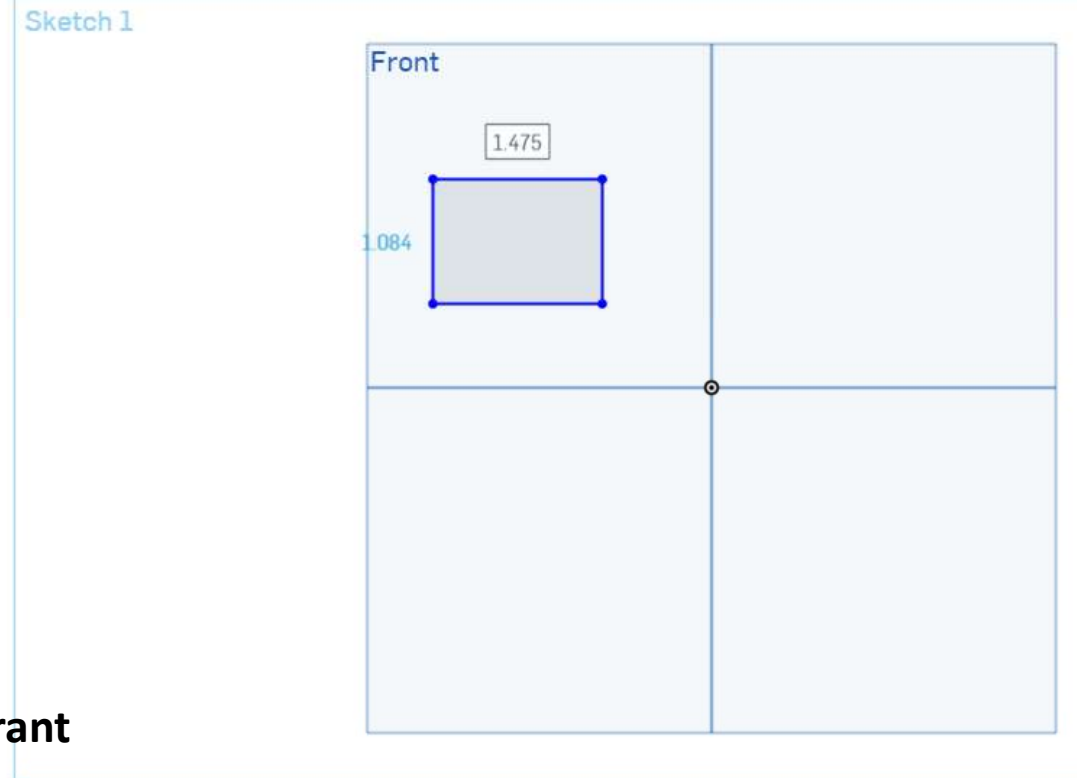

N for normal
Select Rectangle
Drag in upper left quadrant

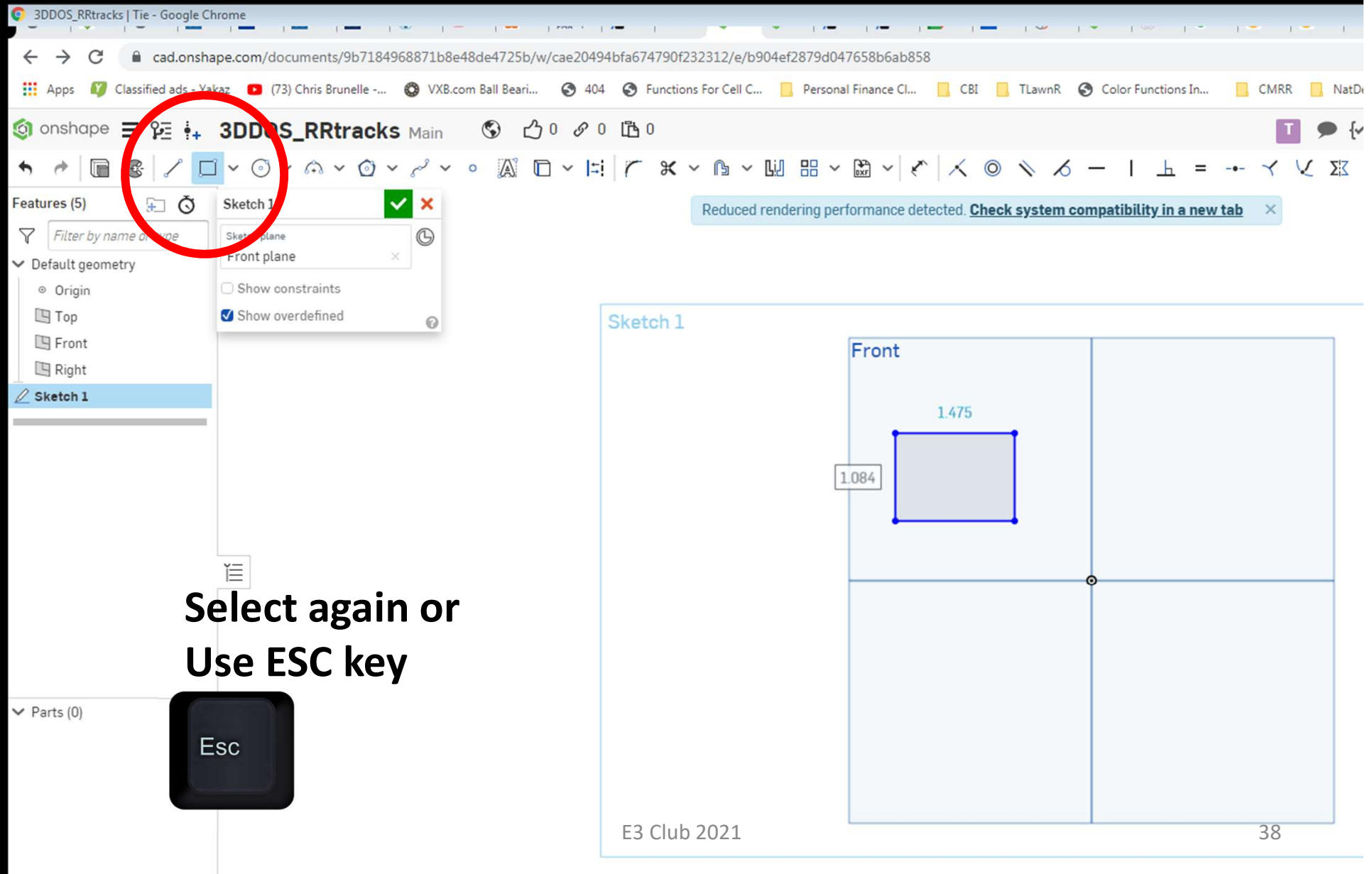

The screenshot shows the Onshape web interface for a document titled "3DDOS_RRtracks". The "Features" tree on the left shows "Sketch 1" selected. A red circle highlights the "Sketch 1" icon in the toolbar. A context menu is open over "Sketch 1", showing options like "Sketch plane", "Front plane", "Show constraints", and "Show overdefined". A warning message at the top right states: "Reduced rendering performance detected. [Check system compatibility in a new tab](#)". The main workspace shows a "Front" view of a sketch with a rectangle. The rectangle has dimensions of 1.475 (width) and 1.084 (height). The text "E3 Club 2021" is visible in the bottom left corner of the workspace, and the number "38" is in the bottom right corner.

**Select again or
Use ESC key**





Center lines at Origin

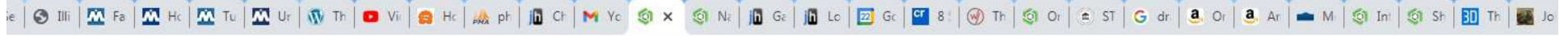

cad.onshape.com/documents/9b7184968871b8e48de4725b/w/cae20494bfa674790f232312/e/b904ef2879d047658b6ab858

Classified ads - Yakaz (73) Chris Brunelle -... VXB.com Ball Beari... 404 Functions For Cell C... Personal Finance Cl... CBI TLawnR Color Functions In... CMRR NatDet 3DPrint Account The



Sketch 1

name or type

Sketch plane

Front plane

Show constraints

Show overdefined

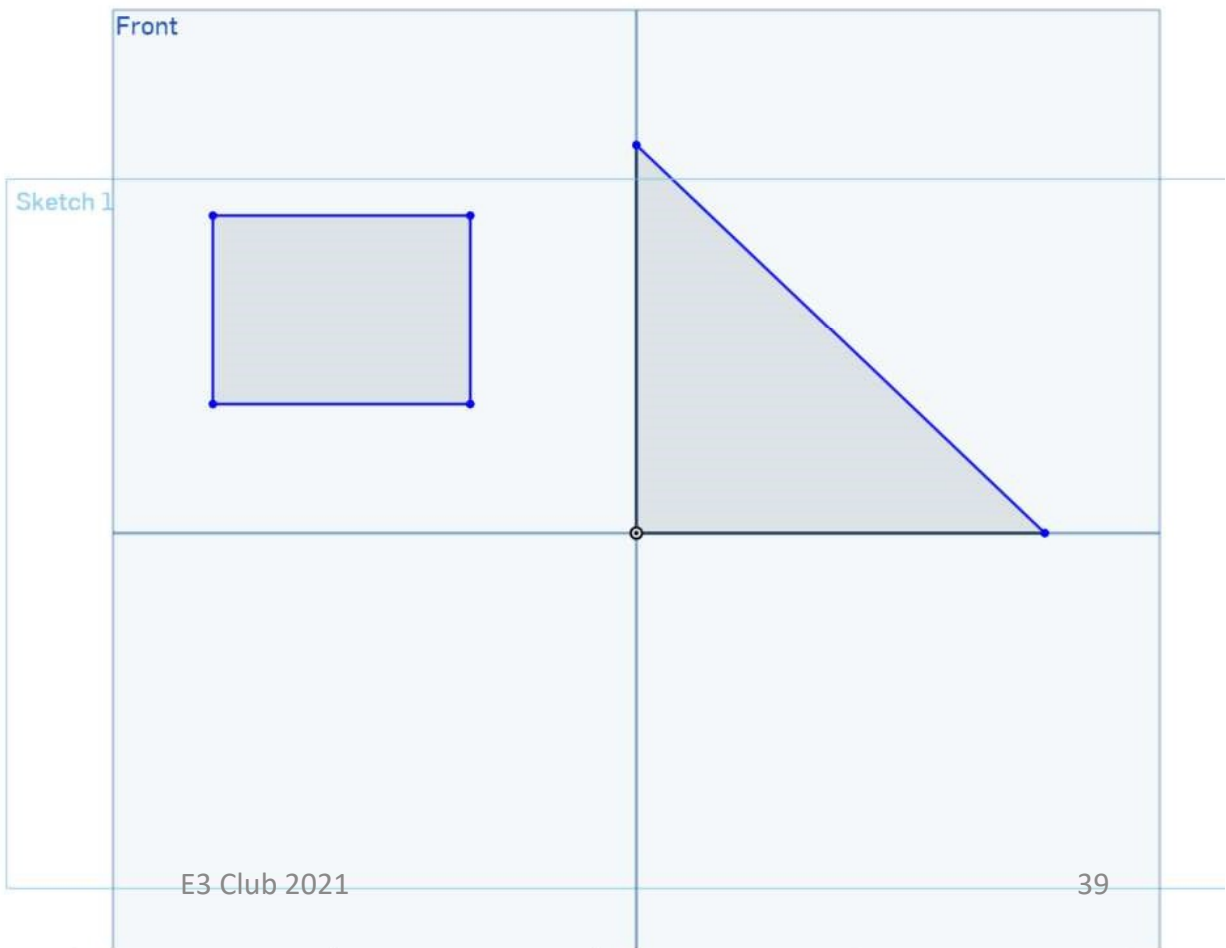

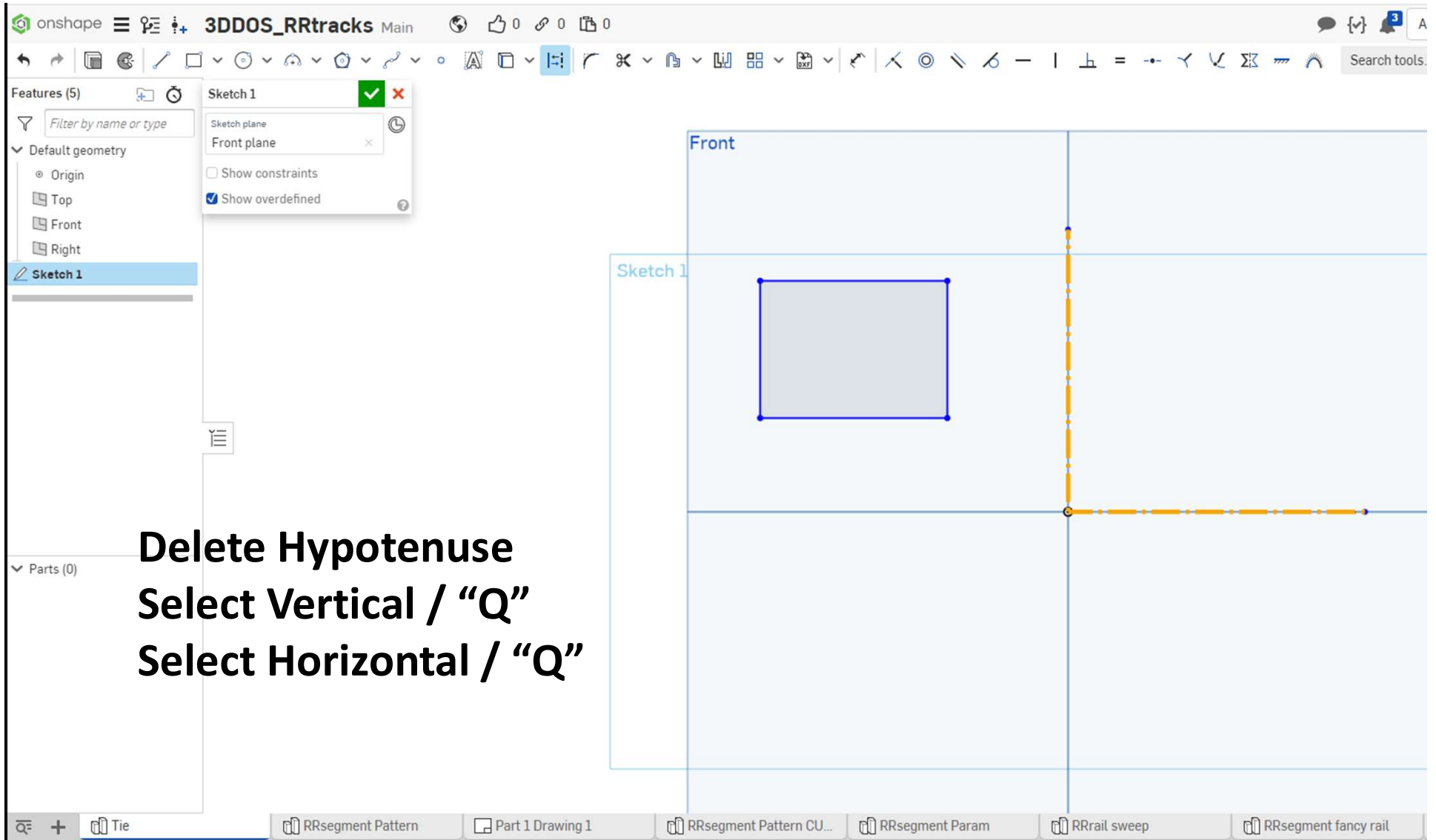

Delete Hypotenuse
Select Vertical / "Q"
Select Horizontal / "Q"

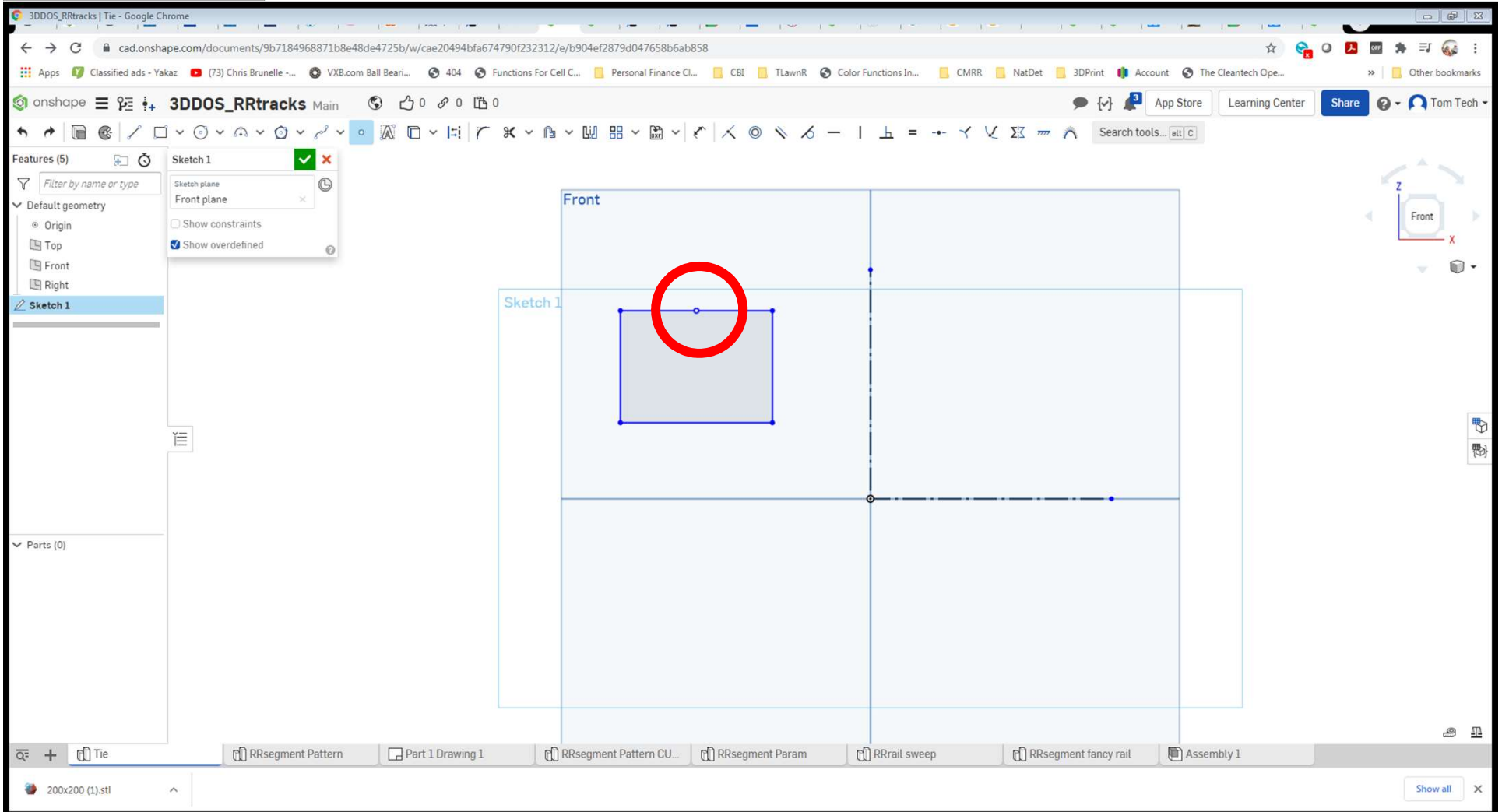

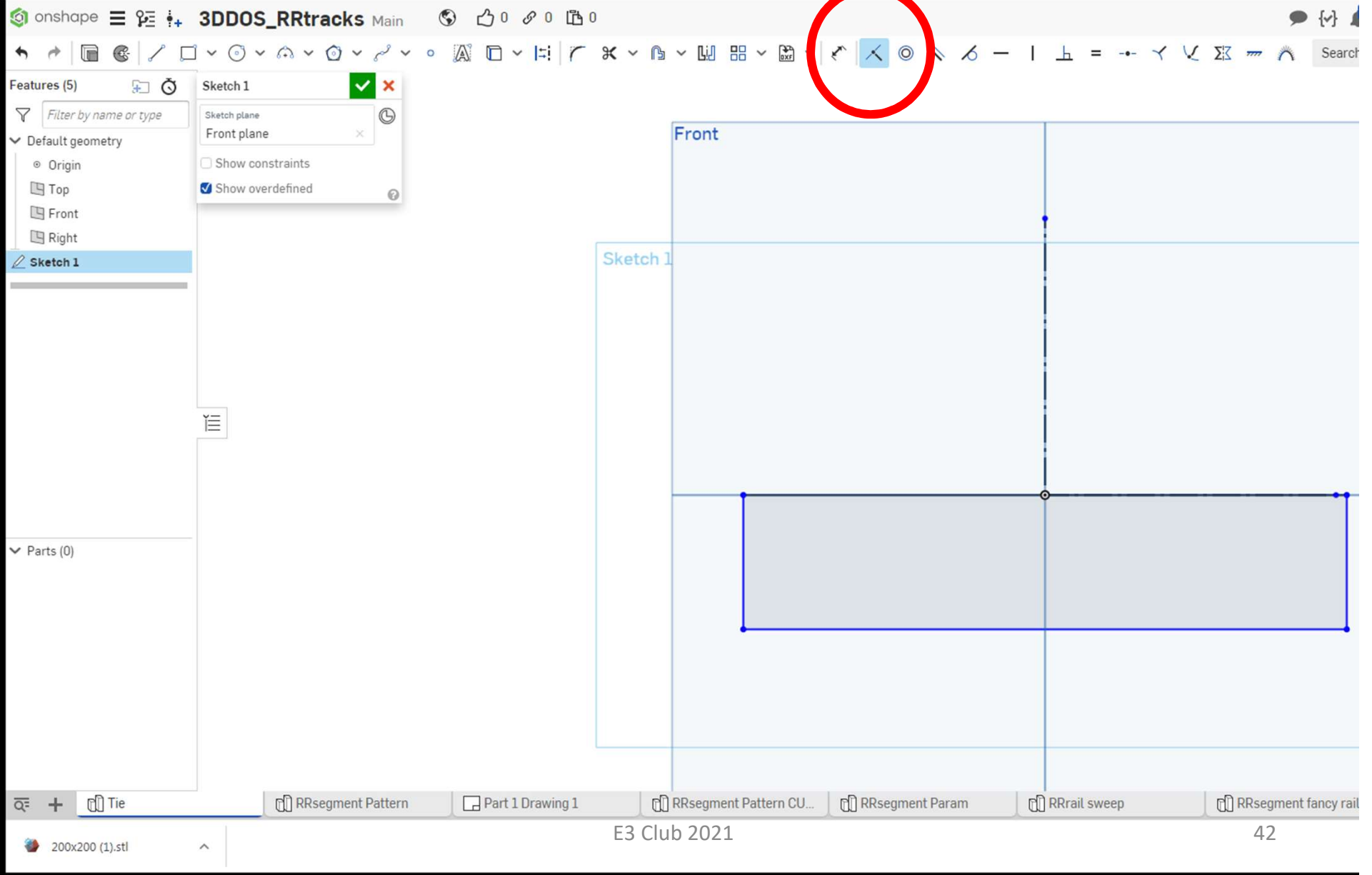

The screenshot displays the Onshape web interface for a project named "3DDOS_RRtracks". The main workspace shows a "Front" view of a sketch on the "Front plane". A rectangular sketch is centered on the origin of the coordinate system. A red circle highlights the center tool icon in the top toolbar. The left sidebar shows the "Features" tree with "Sketch 1" selected. The bottom status bar shows the current view is "200x200 (1).stl" and the page number is 42.

onshape 3DDOS_RRtracks Main

Sketch 1

Sketch plane: Front plane

Show constraints

Show overdefined

Sketch 1

7

9

Front

E3 Club 2021

43

The screenshot displays the Onshape software interface. At the top, the title bar shows 'onshape 3DDOS_RRtracks Main'. The toolbar contains various icons, with the 'Radius Corner' tool (a blue square with a rounded corner) highlighted by a red circle. On the left, the 'Features (5)' panel is visible, with 'Sketch 1' selected. Below it, the 'Default geometry' panel lists 'Origin', 'Top', 'Front', and 'Right'. The 'Sketch 1' properties panel shows 'Sketch plane: Front plane', 'Show constraints' (unchecked), and 'Show overdefined' (checked). The main workspace shows a sketch on the 'Front' plane. The sketch consists of a rectangle with rounded corners, labeled 'R1' at each corner. A vertical dimension line on the left indicates a height of 7. Dashed lines represent the original rectangular boundaries and the center of the radius arcs. The 'Front' plane is also labeled in the sketch area.



Extrude (Shift-e)

Create, add to, subtract from, or intersect parts by extruding sketch regions or planar faces, or surfaces by extruding lines or curves.

1. Select regions or faces, or sketch edges.
2. Specify whether to create a new part or surface, add, remove, or intersect with existing parts
3. Specify the distance or the entity to extrude up to.

Front

Right

Sketch 1

Parts (0)

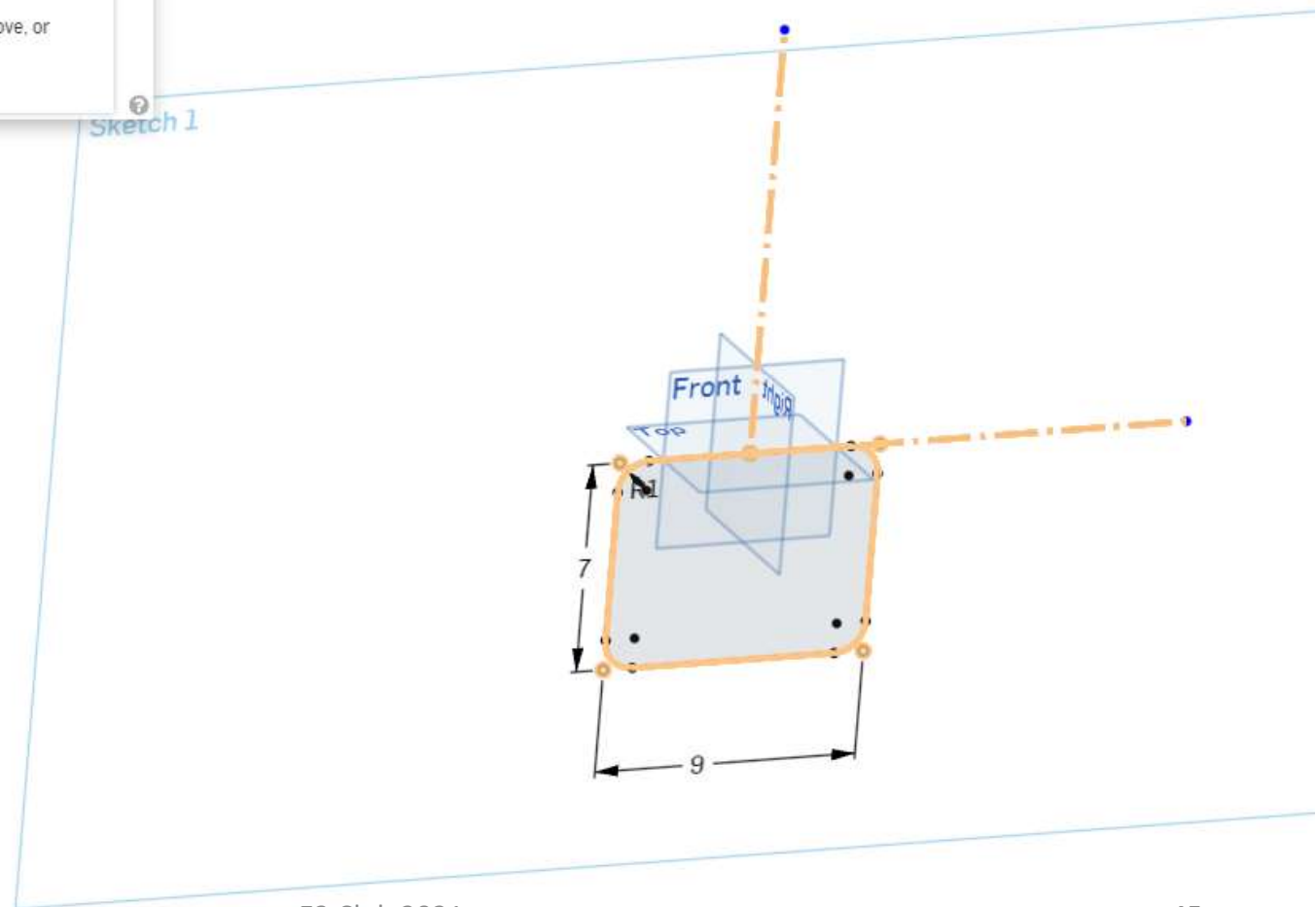

Set length (symmetric)



Features (6)

Filter by name or type

Default geometry

- Origin
- Top
- Front
- Right

Sketch 1

Extrude 1

Extrude 1

Solid Surface

New Add Remove Intersect

Faces and sketch regions to extrude

Faces of Sketch 1

Symmetric

Depth 102 in

Draft

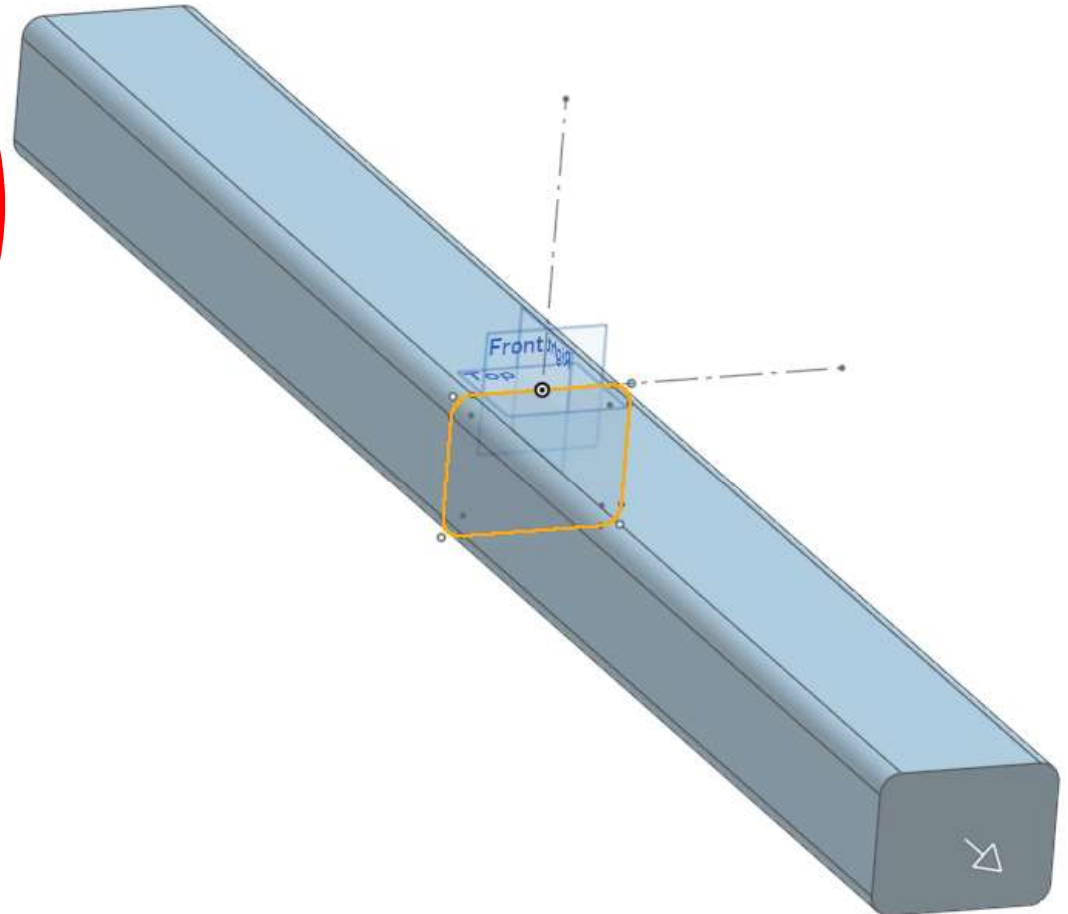

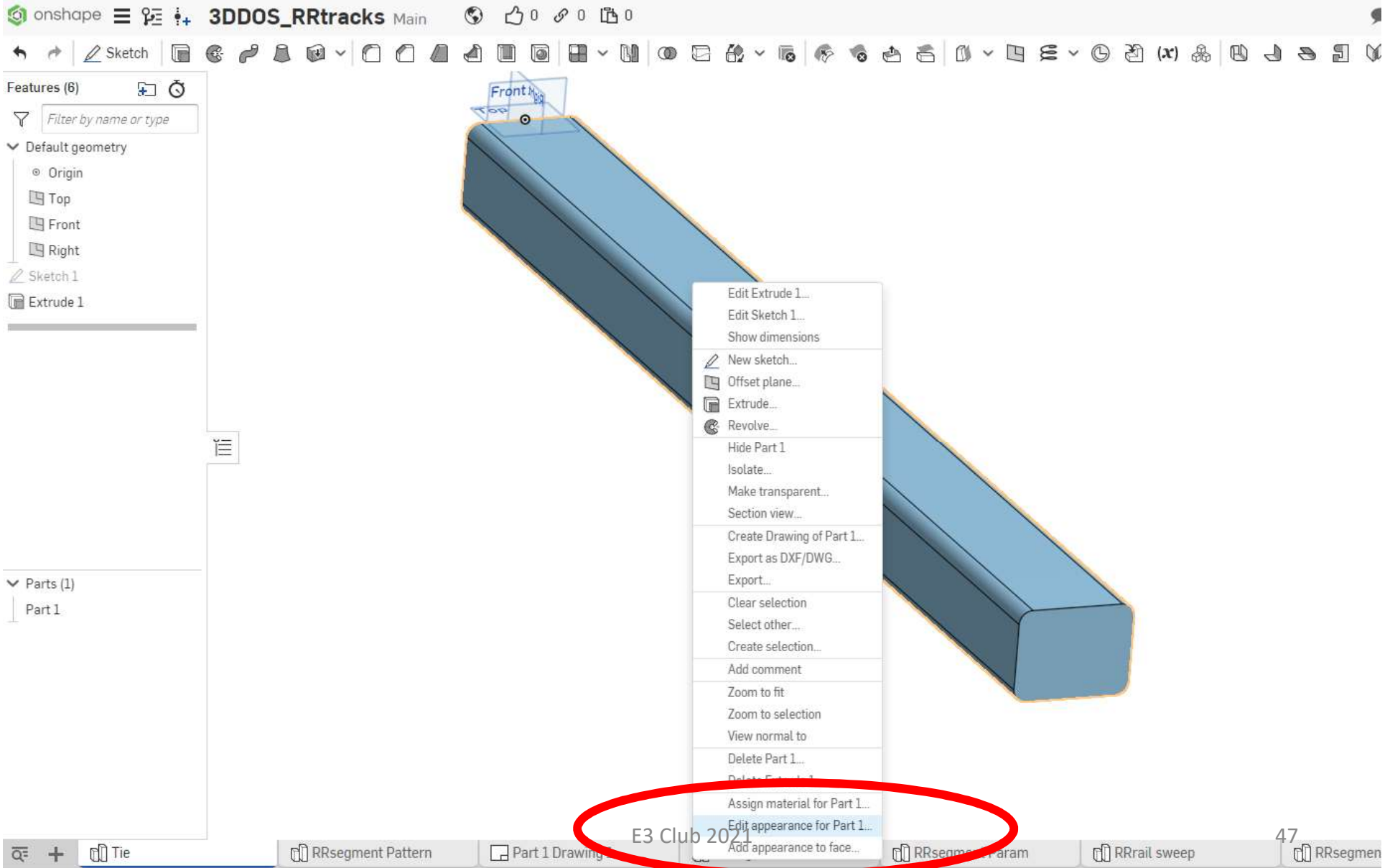

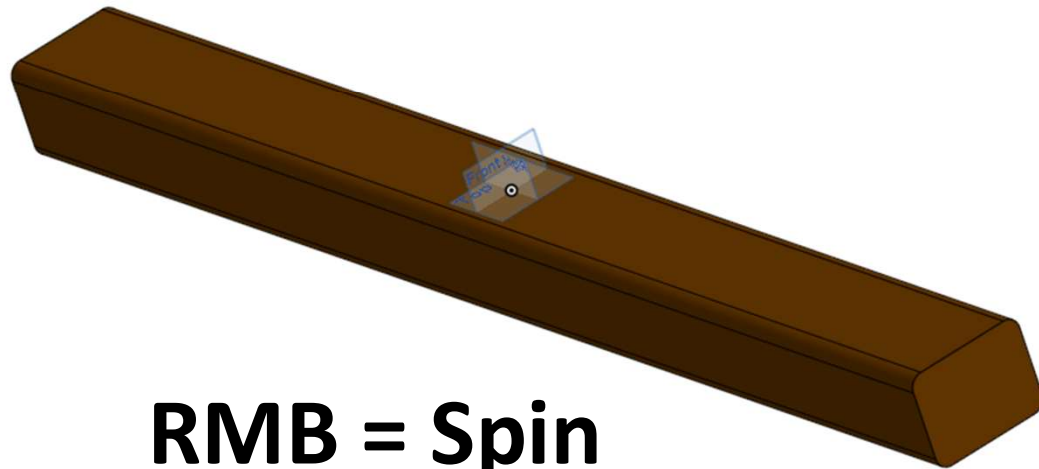
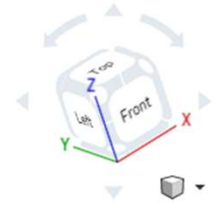

RMB = Spin

MMB = Pan

MSW = Zoom (F for Fit)

1. Zoom = M _____ S _____ W _____
2. 3D rotate = R _____ M _____ B _____
3. Pan = M _____ M _____ B _____
4. Feature or Object Select = L _____ M _____ B _____ (Glowing lines on hover, orange when selected)
5. Key- ___ for ___ormal, presents sketch or feature perpendicular
6. 3D V _____ C _____
7. S _____ Left C _____ for multiple selection
8. Ctl- _____ is your friend (undo)
9. Line type Toggle- Key _____ (construction to solid)
10. Planes show/no-show Toggle- Key _____ for _____lane
11. View Extents – Key- ___for ___it



1. 3 BASIC FEATURES

1. E _____
2. R _____
3. S _____

2. 2 MAJOR MODES

1. F _____
2. S _____

3. FOUNDATIONAL GEOMETRY

1. F _____ P _____
2. R _____ P _____
3. T _____ P _____
4. O _____

4. LITTLE ICONS = C _____

5. F _____ T _____ = list of features

onshape 3DDOS_RRtracks Main



Features (7)

Filter by name or type

Default geometry

- Origin
- Top
- Front
- Right

- Sketch 1
- Extrude 1
- Sketch 2**

Sketch 2

Sketch plane
Front plane

- Show constraints
- Show overdefined

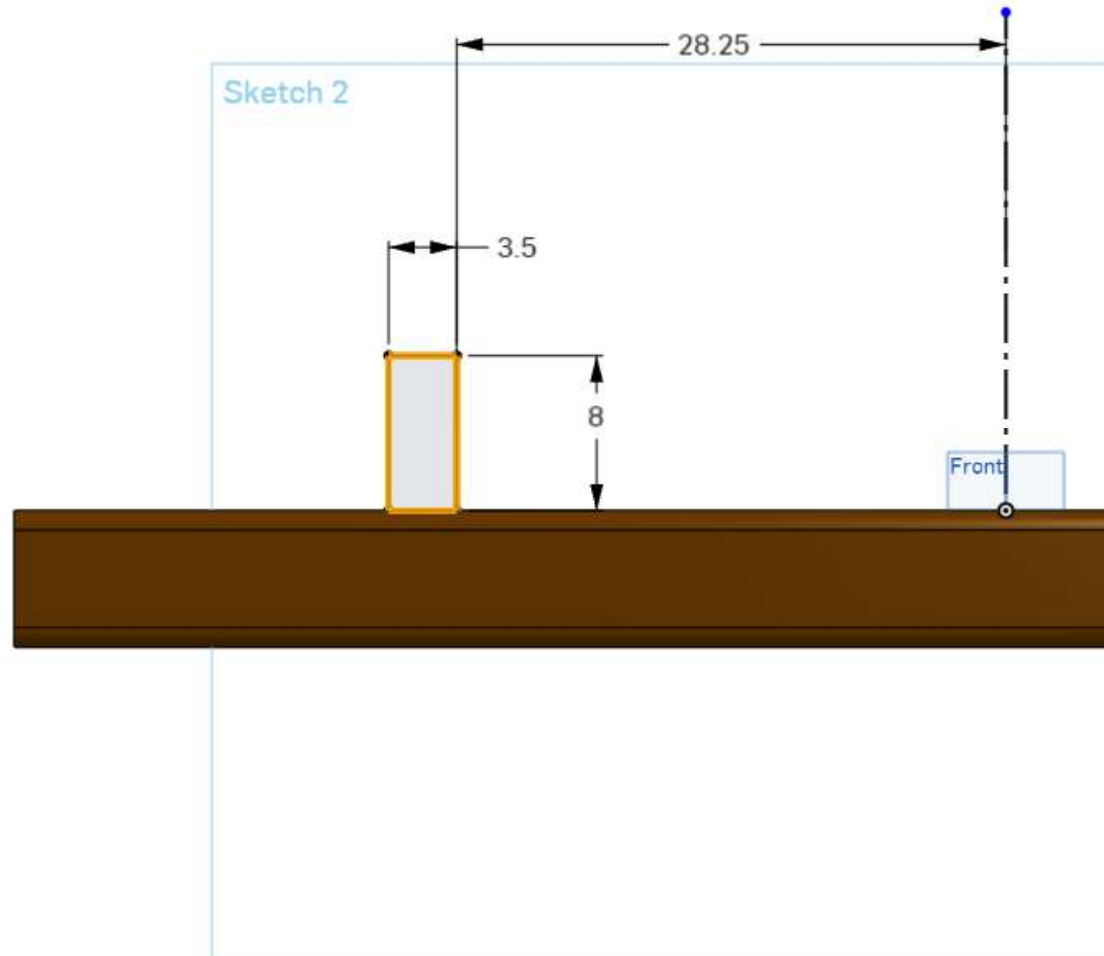

Parts (1)

Part 1

The screenshot displays the Onshape CAD interface for a project named "3DDOS_RRtracks". The main workspace shows a 3D model of a brown rail with a grey rectangular extrusion being applied to its top surface. A dashed line indicates the extrusion's direction. The "Extrude 2" feature panel is open, showing the following settings:

- Extrude 2** (checked)
- Solid** (selected)
- Blind** (selected)
- Depth**: 19.5 in
- Draft**: unchecked
- Second end position**: unchecked

The left sidebar shows the "Features (9)" list with "Extrude 2" selected. Below it, the "Parts (2)" list shows "Part 1" and "Part 2". The bottom status bar includes tabs for "Tie", "RRsegment Pattern", "Part 1 Drawing 1", "RRsegment Pattern CU...", "RRsegment Param", "RRrail sweep", and "RRsegment fancy rail". The bottom right corner displays "E3 Club 2021" and the page number "52".



Features (9)

Filter by name or type

- Default geometry
 - Origin
 - Top
 - Front
 - Right
- Sketch 1
- Extrude 1
- Sketch 2
- Extrude 2
- Mirror 1**

Mirror 1

Part mirror

New Add Remove Intersect

Entities to mirror

Part 2

Mirror plane

Right plane

Merge with all

Merge scope

Part 2

Boolean resulted in no geometry change. The parts either do not intersect or are totally contained.

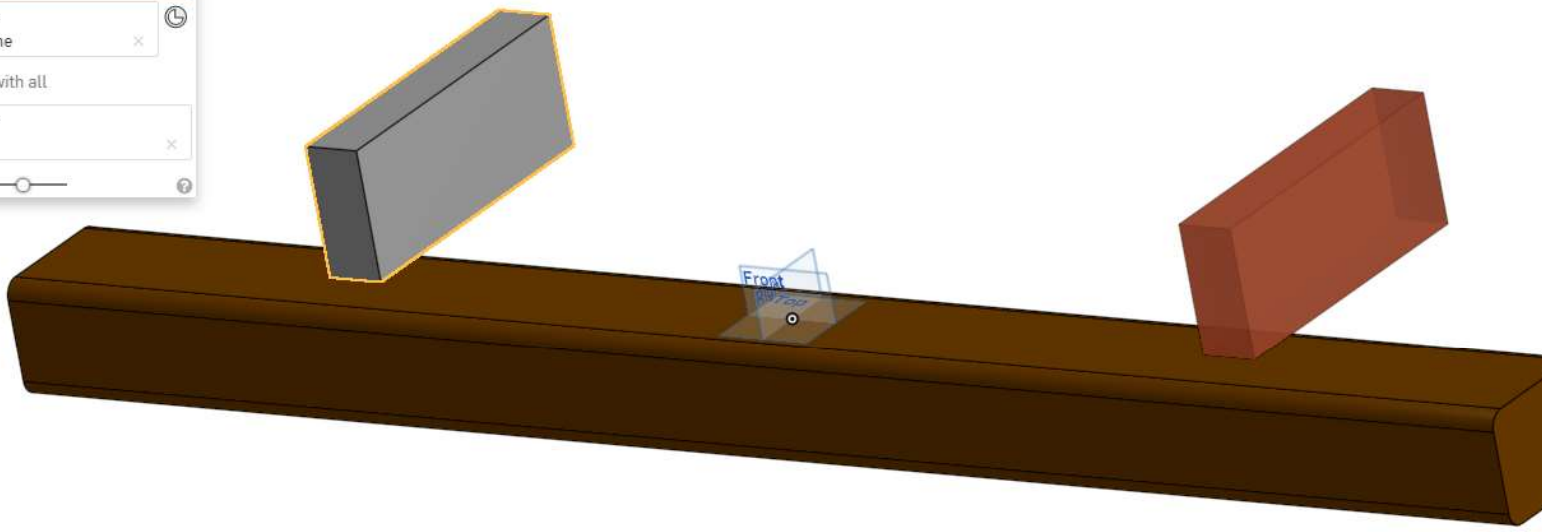

Parts (3)

- Part 1
- Part 2**
- Part 3



onshape 3DDOS_RRtracks Main

Linear pattern

Create multiple instances of parts, faces or features uniformly in one or two directions.

1. Select parts, faces or features to pattern.
2. Select the directions in which to pattern.
3. Specify the distance in each direction.
4. Specify the number of instances.

Features (9)

- Filter by name or type
- Default geometry
 - Origin
 - Top
 - Front
 - Right
- Sketch 1
- Extrude 1
- Sketch 2
- Extrude 2
- Mirror 1

Parts (3)

- Part 1
- Part 2
- Part 3

E3 Club 2021

54

Tie RRsegment Pattern Part 1 Drawing 1 RRsegment Pattern CU... RRsegment Param RRrail sweep RRsegm

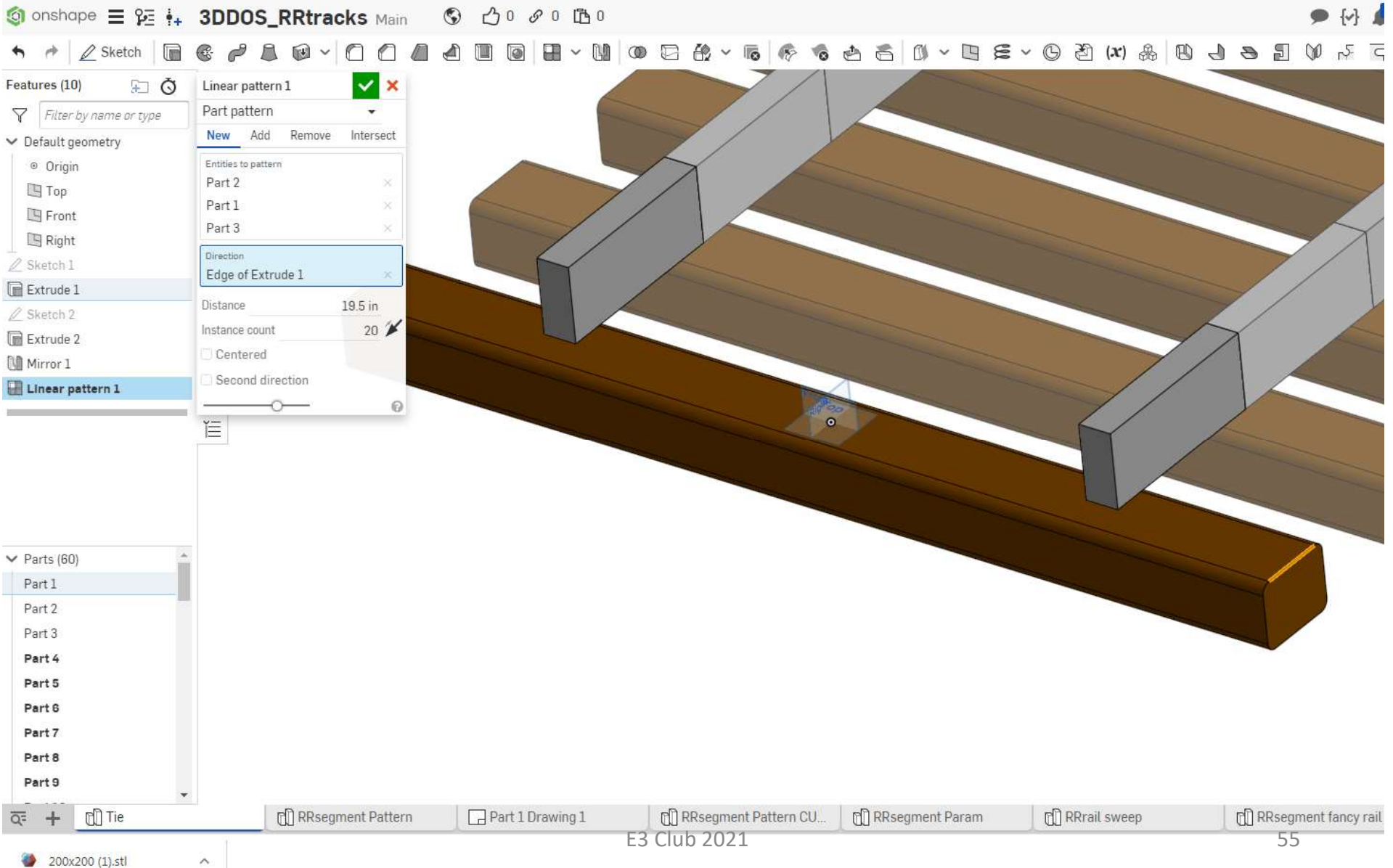

The screenshot displays the Onshape CAD interface for a project named "3DDOS_RRtracks". The main workspace shows a 3D model of a rail track assembly with several parallel rails and cross-ties. A "Linear pattern 1" dialog box is open, showing the following settings:

- Part pattern:** Includes "Part 2", "Part 1", and "Part 3".
- Direction:** "Edge of Extrude 1".
- Distance:** "19.5 in".
- Instance count:** "20".
- Centered:** (unchecked).
- Second direction:** (unchecked).

The left-hand "Features" tree shows a sequence of operations: Origin, Top, Front, Right, Sketch 1, Extrude 1, Sketch 2, Extrude 2, Mirror 1, and Linear pattern 1. The bottom "Parts" tree lists "Part 1" through "Part 9". The taskbar at the bottom includes tabs for "Tie", "RRsegment Pattern", "Part 1 Drawing 1", "RRsegment Pattern CU...", "RRsegment Param", "RRrail sweep", and "RRsegment fancy rail". The status bar at the bottom indicates "200x200 (1).stl" and "E3 Club 2021".

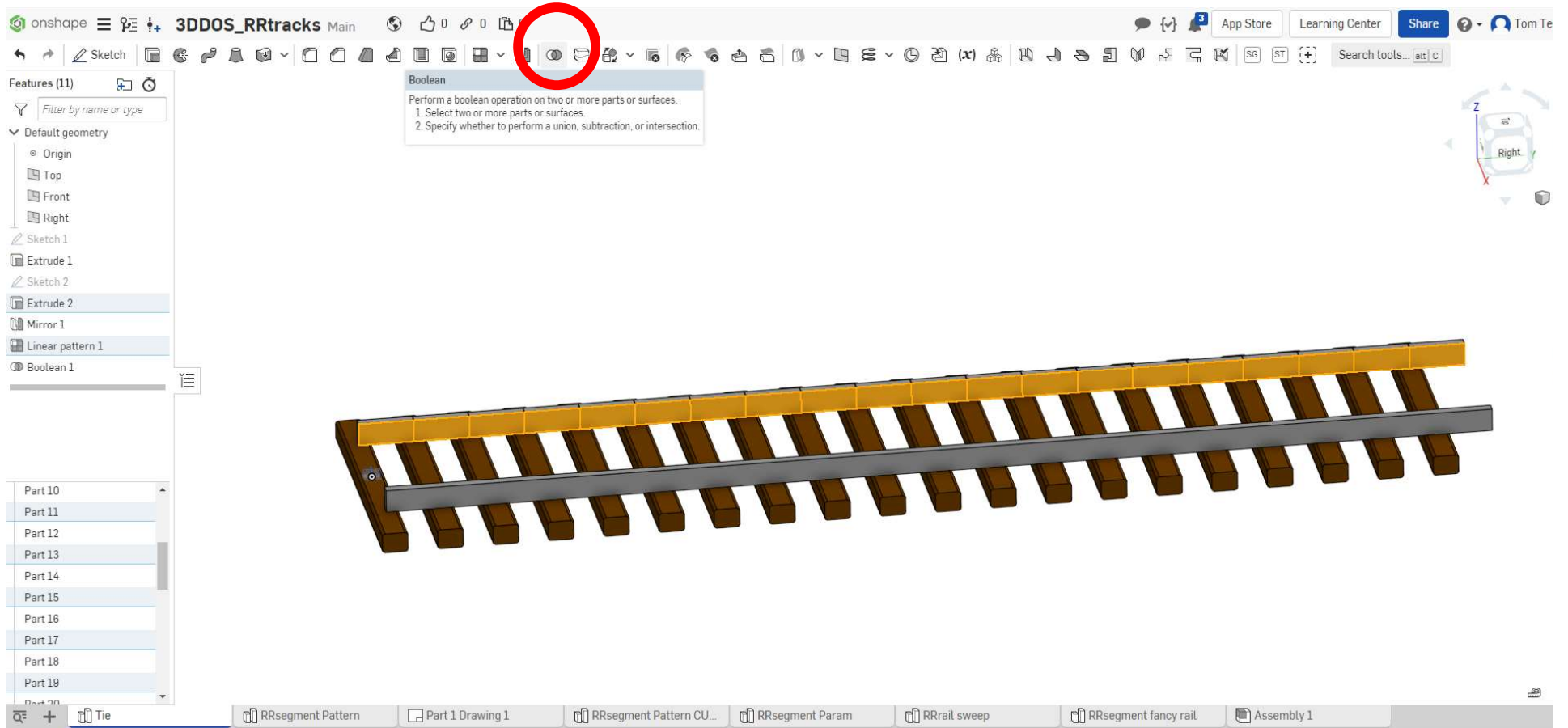

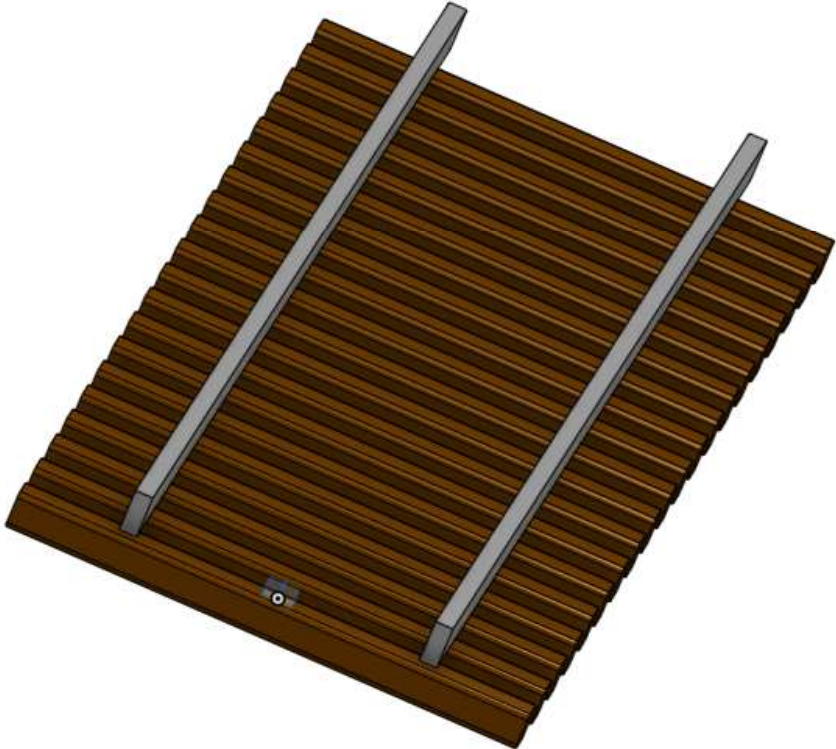
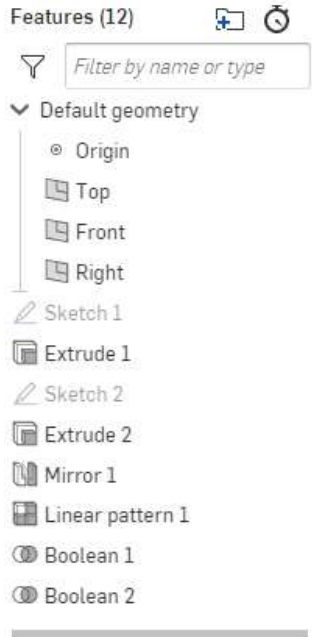

RMB = Spin
MMB = Pan
MSW = Zoom (F for Fit)

The screenshot displays the Onshape CAD environment for a part named '3DDOS_RRtracks'. The interface includes a top toolbar with various tools, a left-hand 'Features' tree, and a central 3D view area. In the 'Features' tree, 'Sketch 2' is highlighted with a red circle. A 'Sketch 2' dialog box is open, showing 'Sketch plane: Front plane' and options for 'Show constraints' (unchecked) and 'Show overdefined' (checked). The 3D view shows a brown base with a grey rectangular feature on top. Dimensions are indicated: a total width of 28.25, a top width of 3.5, a height of 8, and a bottom offset of 0.5. The 'Front' view is selected, and a 'Final' button is visible in the sketch dialog.

Add tie plate

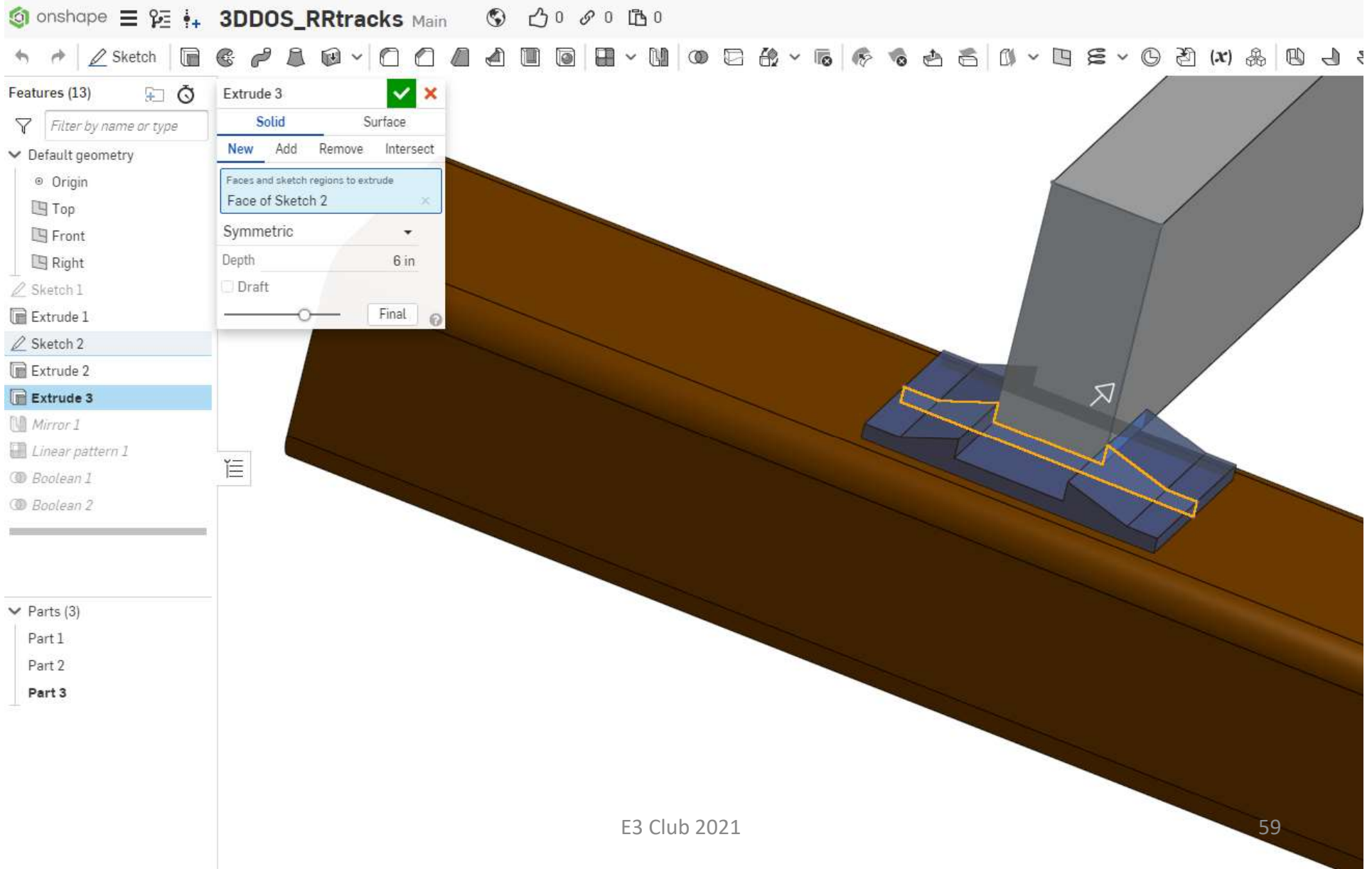

The screenshot displays the Onshape CAD interface for a part named '3DDOS_RRtracks'. The 'Features' tree on the left lists: Default geometry (Origin, Top, Front, Right), Sketch 1, Extrude 1, Sketch 2, Extrude 2, **Extrude 3**, Mirror 1, Linear pattern 1, Boolean 1, and Boolean 2. The 'Parts' tree shows Part 1, Part 2, and **Part 3**. The 'Extrude 3' feature dialog is open, showing 'Solid' and 'Surface' tabs, with 'New' selected. It lists 'Face of Sketch 2' as the extrusion target, with a depth of 6 in and the 'Draft' checkbox unchecked. The main view shows a brown rail with a blue tie plate being extruded from a sketch on its top surface.

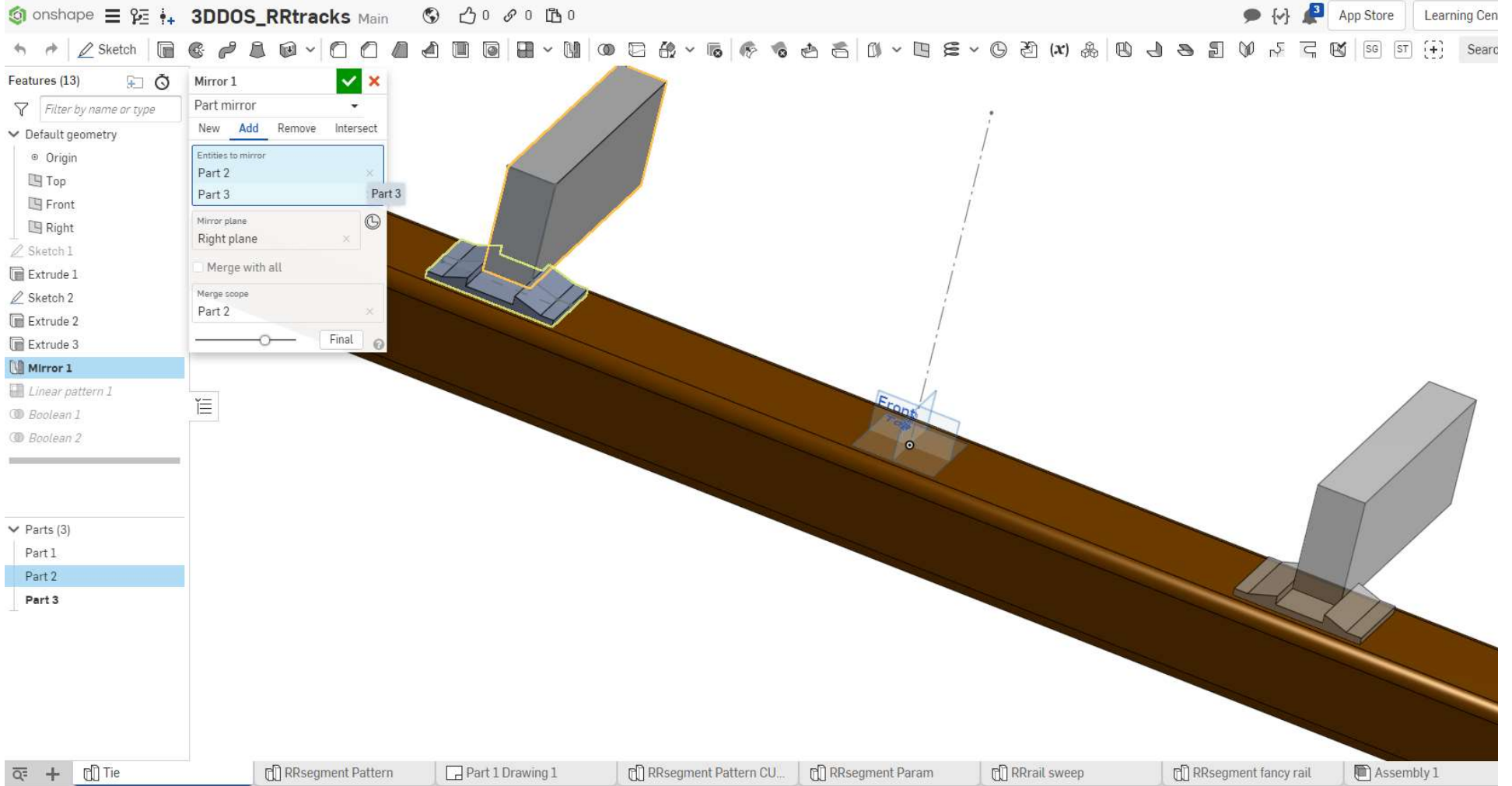

onshape 3DDOS_RRtracks Main

Features (14)

- Filter by name or type
- Default geometry
 - Origin
 - Top
 - Front
 - Right
- Sketch 1
- Extrude 1
- Sketch 2**
- Extrude 2
- Extrude 3
- Mirror 1
- Linear pattern 1
- Boolean 1
- Boolean 2
- Transform 1

Parts (1)

- Part 1

Sketch 2

- Sketch plane: Front plane
- Show constraints:
- Show overdefined:
- Final

Insert image

Choose an image and then create a rectangle to define the image position and size.

1. In the dialog that appears, choose the desired image from any document you have access to. If no image files are listed, use the Import link at the bottom of the dialog to import a file.
2. Click and drag to create a rectangle; the lower left corner defines the image position. The image aspect ratio is maintained.

0.5

8

E3 Club 2021

61

Tie RRsegment Pattern Part 1 Drawing 1 RRsegment Pattern CU... RRsegment Param RRrail sweep RRsegme

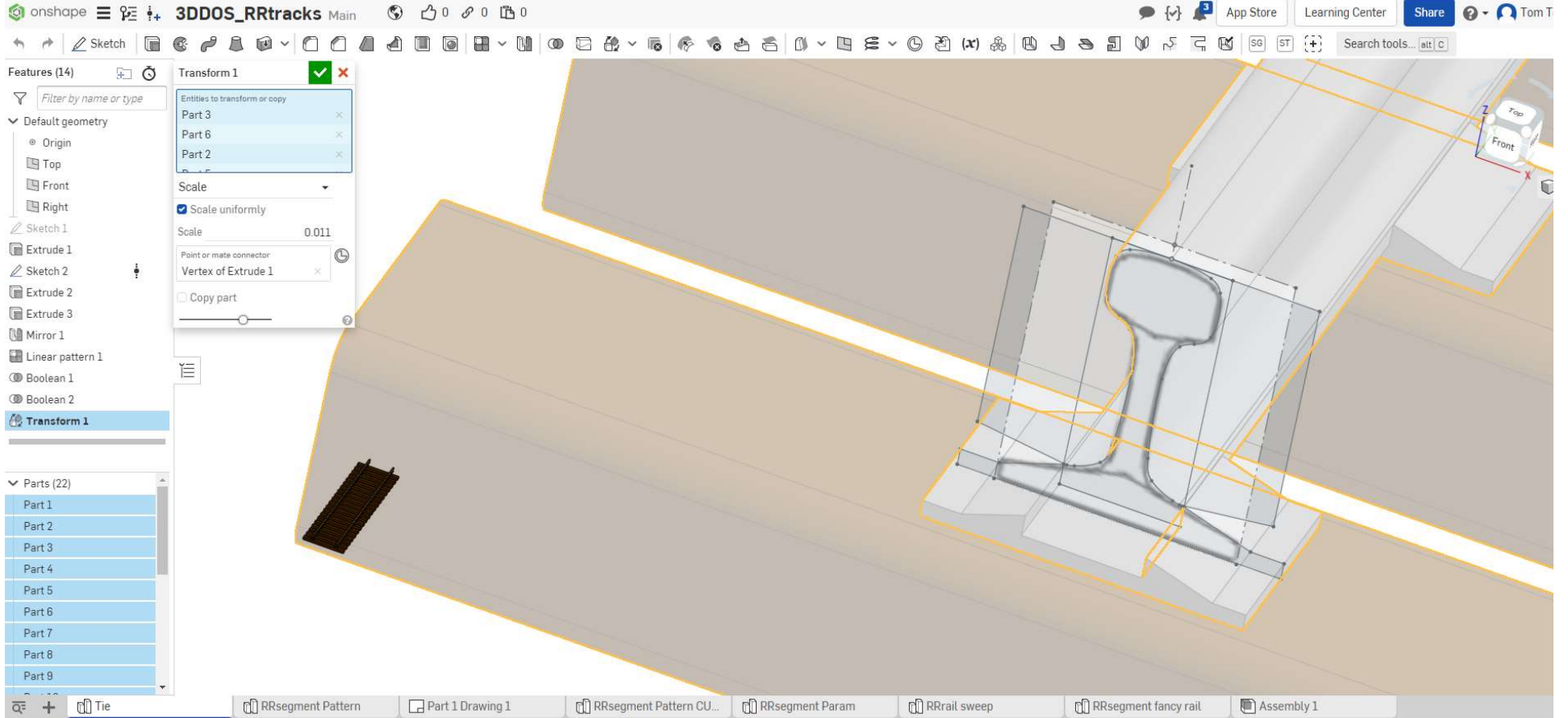

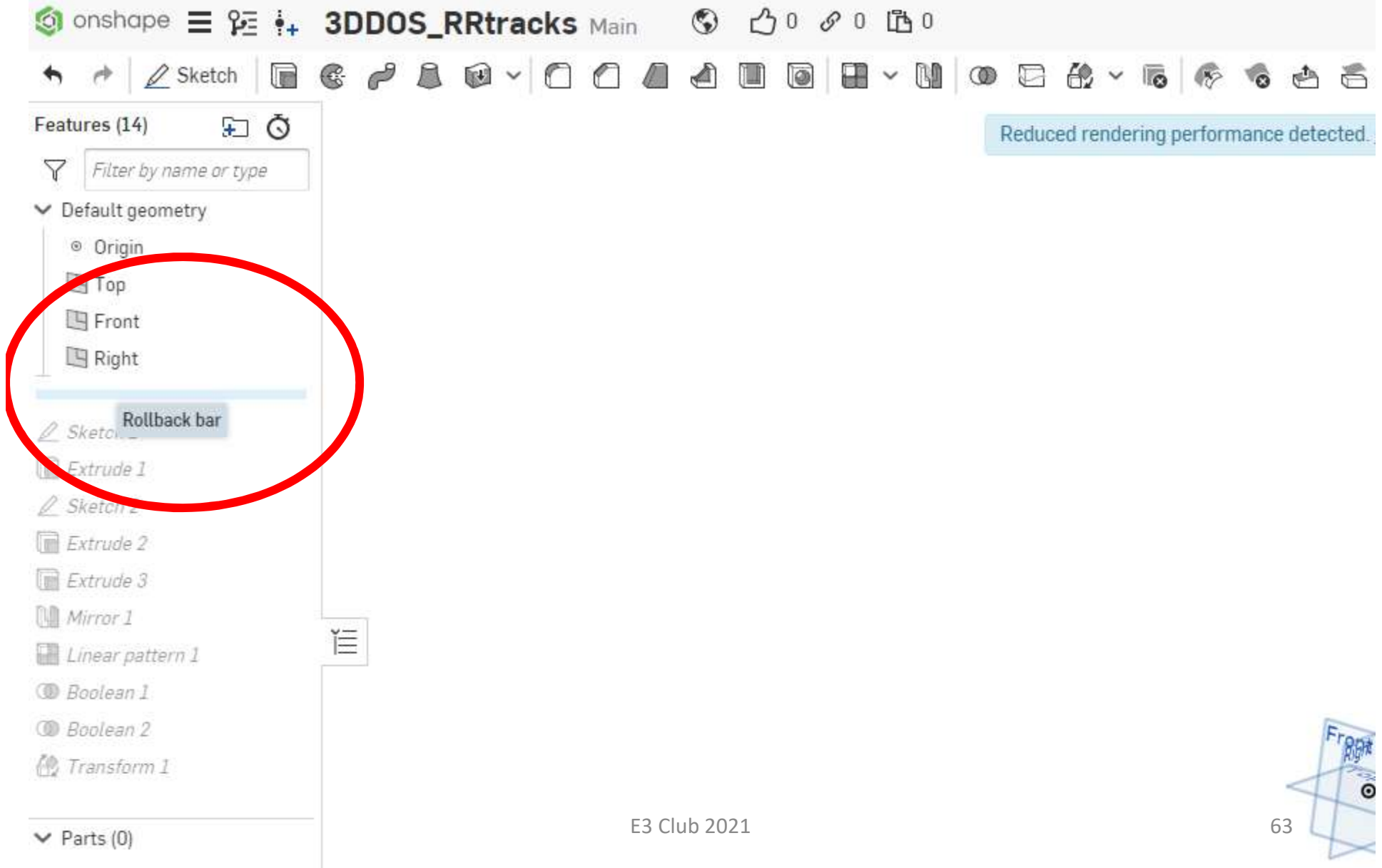

The screenshot shows the Onshape web interface for a file named "3DDOS_RRtracks". The top navigation bar includes the Onshape logo, a menu icon, and icons for home, share, and download. The main toolbar contains various modeling tools like Sketch, Extrude, and Mirror. On the left, the Features tree lists 14 features, including "Default geometry" (Origin, Top, Front, Right), "Sketch 1", "Extrude 1", "Sketch 2", "Extrude 2", "Extrude 3", "Mirror 1", "Linear pattern 1", "Boolean 1", "Boolean 2", and "Transform 1". A red circle highlights a horizontal bar between the "Default geometry" and "Sketch 1" features, labeled "Rollback bar". A notification in the top right corner states "Reduced rendering performance detected...".





Features (15)

Filter by name or type

- Default geometry
 - Origin
 - Top
 - Front
 - Right
- (x) #TieWidth = 9 in**
- Sketch 1
- Extrude 1
- Sketch 2
- Extrude 2
- Mirror 1
- Linear pattern 1
- Boolean 1
- Boolean 2
- Transform 1
- Parts (0)

#TieWidth = 9 in

Length	Angle	Number	Any
Name	TieWidth		
Value	9 in		

Reduced rendering performance detected. [Check](#)

Variable

Assign a variable that is visible inside this Part Studio. Use the # symbol to refer to a variable in a numeric field.

1. Click the Variable icon.
2. In the dialog, specify a name and numeric value.
3. In any numeric field, use # and the variable name.

For example, when the variable is x, enter #x in the numeric field. The variable can also be used in expressions, as in #x * 2 which doubles the variable x.



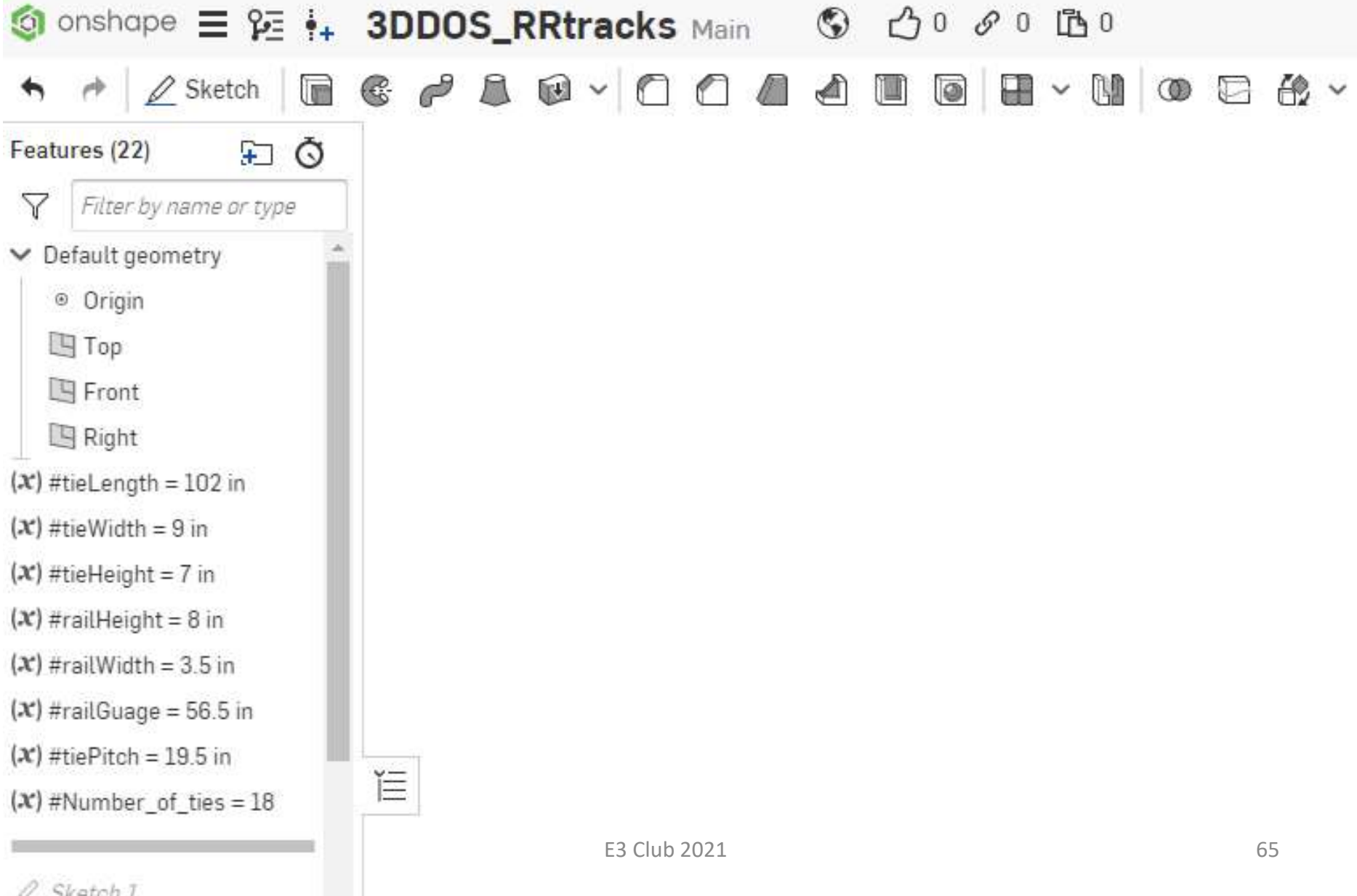

The screenshot shows the Onshape web interface for a project named "3DDOS_RRtracks". The top toolbar includes navigation and editing tools like "Sketch", "Move", "Copy", and "Paste". The left sidebar displays the "Features (22)" tree, which is filtered by name or type. Under the "Default geometry" section, several variables are listed, each with a red 'x' icon indicating they are defined as variables:

- (x) #tieLength = 102 in
- (x) #tieWidth = 9 in
- (x) #tieHeight = 7 in
- (x) #railHeight = 8 in
- (x) #railWidth = 3.5 in
- (x) #railGuage = 56.5 in
- (x) #tiePitch = 19.5 in
- (x) #Number_of_ties = 18

At the bottom of the sidebar, a "Sketch 1" feature is visible.

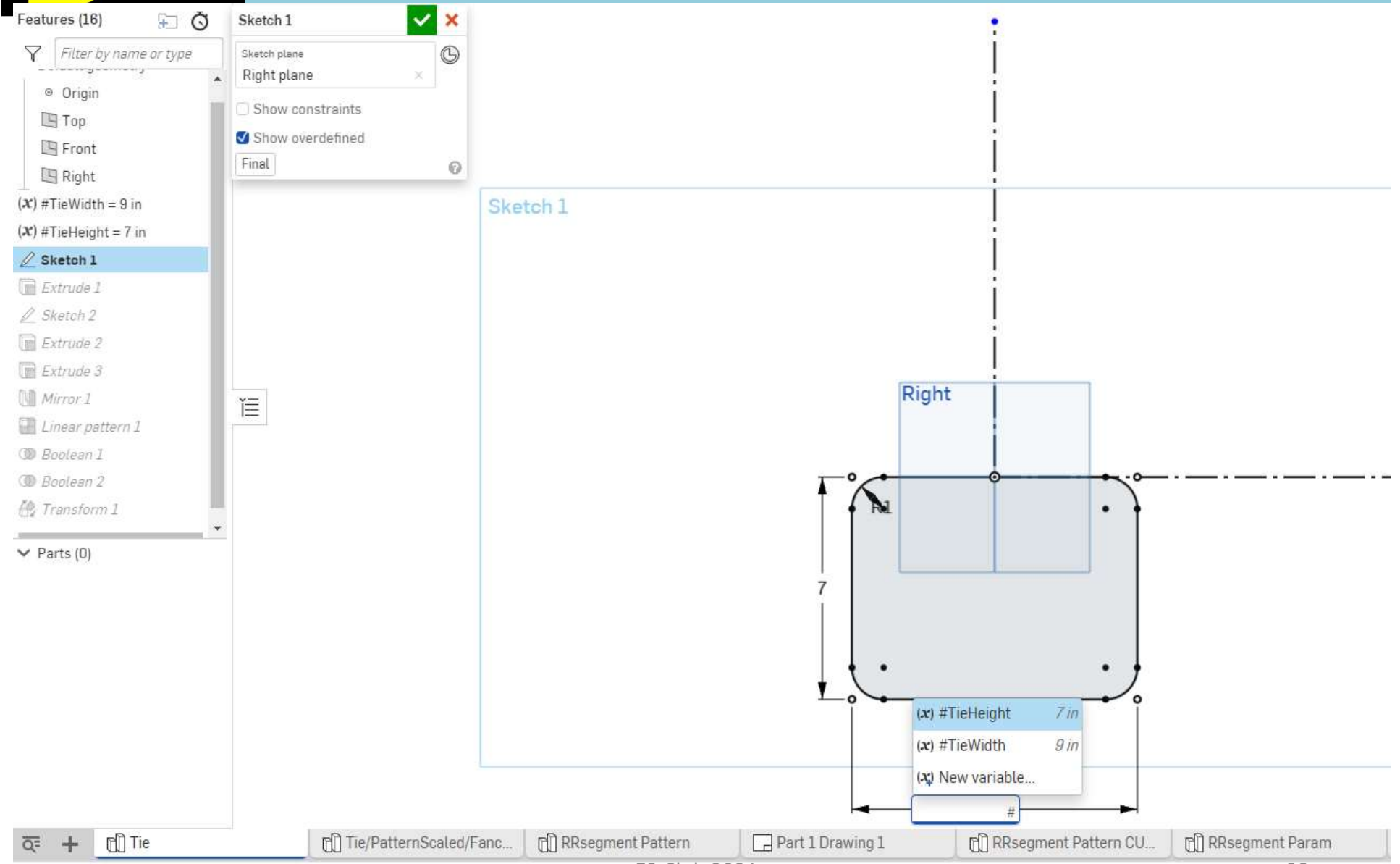

The screenshot displays the Onshape interface. On the left, the 'Features (16)' tree lists: Origin, Top, Front, Right, Sketch 1 (selected), Extrude 1, Sketch 2, Extrude 2, Extrude 3, Mirror 1, Linear pattern 1, Boolean 1, Boolean 2, Transform 1, and Parts (0). The 'Sketch 1' panel shows 'Sketch plane: Right plane', 'Show constraints' (unchecked), 'Show overdefined' (checked), and a 'Final' button. The main workspace shows a sketch on the 'Right' plane of a rounded rectangular part. A dimension of 7 is shown on the left side. A tooltip for the width dimension shows:
(x) #TieHeight 7 in
(x) #TieWidth 9 in
(x) New variable...
A '#' symbol is visible in the dimension input field.

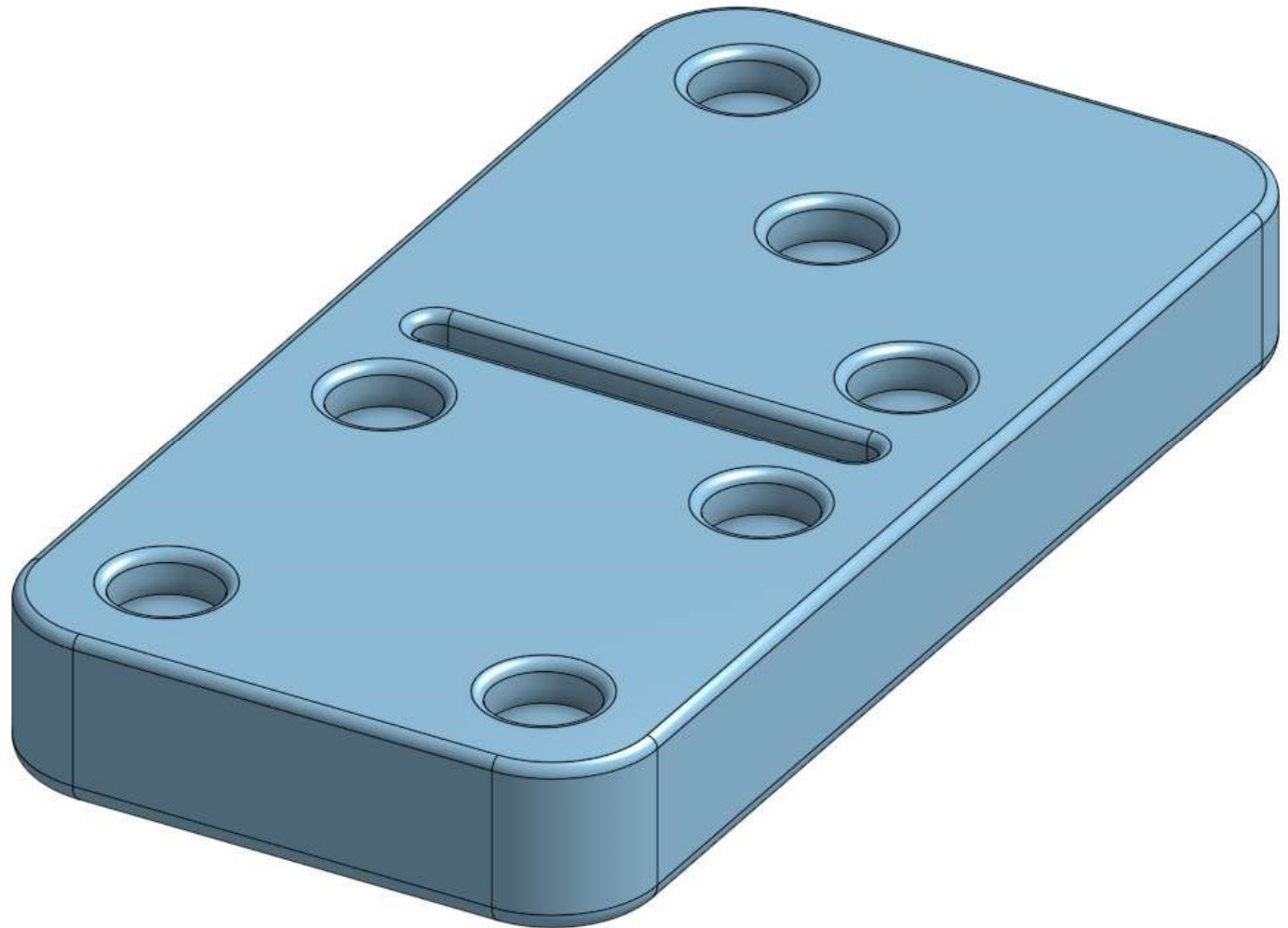

TOP plane Sketch

3DDOS-Domino Main



Domino ✓ ✕

type

Sketch plane
Top plane ✕

Show constraints

Show overdefined

Final ?

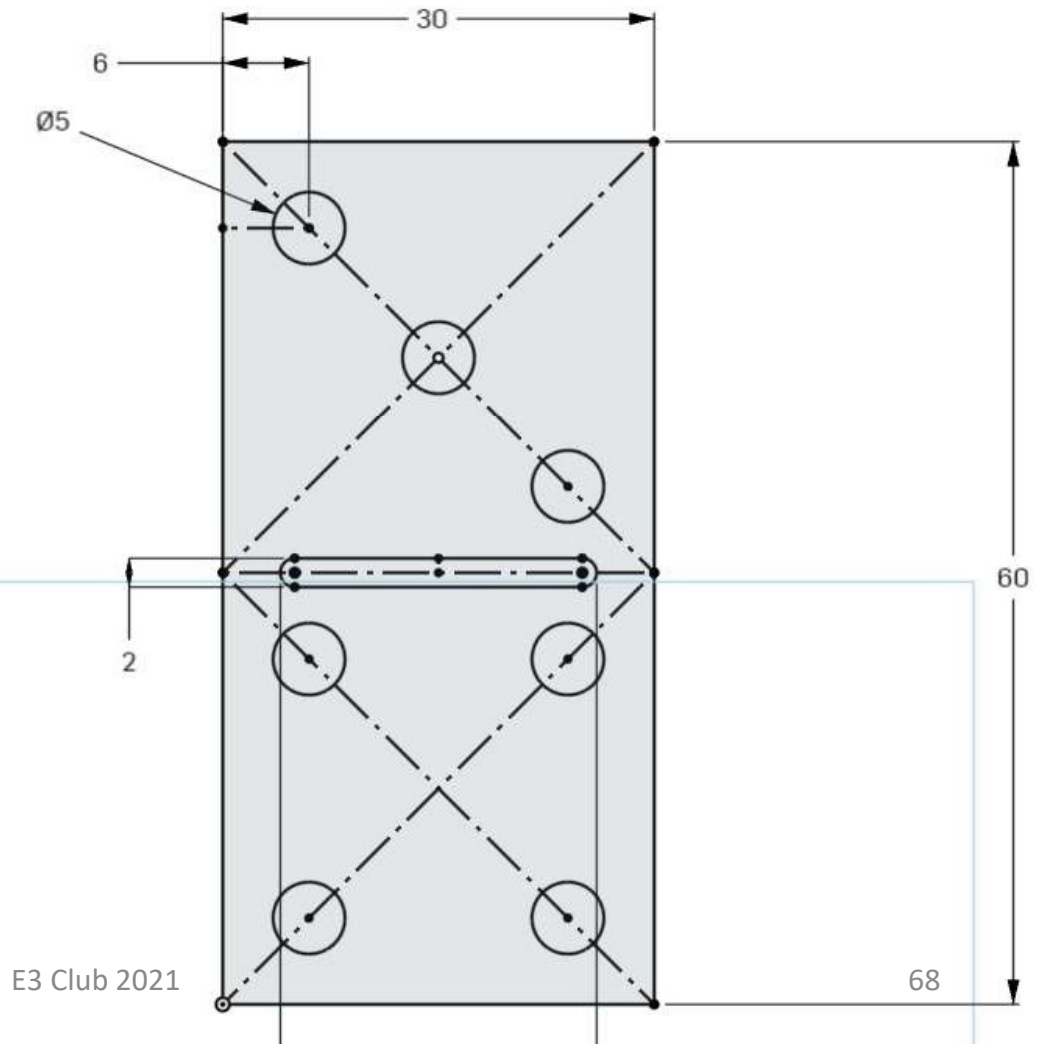

onshape 3DDOS-Domino Main

Sketch

Features (10)

- Origin
- Top
- Front
- Right
- Domino
- Extrude 1**
- Extrude 2
- Fillet 1
- Fillet 2
- Fillet 3

Parts (1)

- Part 1

Extrude 1 ✓ ✕

Solid Surface

New Add Remove Intersect

Faces and sketch regions to extrude

- Face of Domino ✕
- Face of Domino ✕
- Face of Domino ✕

Blind

Depth 6 mm

Draft

Second end position

Final ?

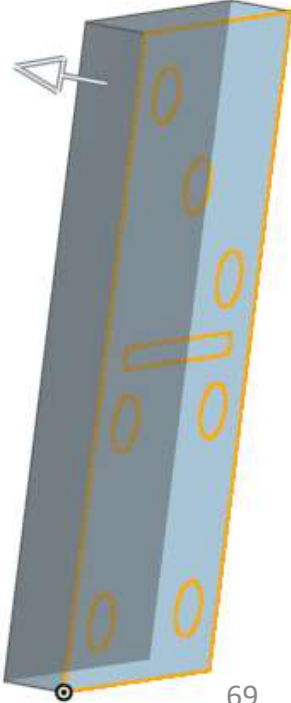

E3 Club 2021

69

Features (10)

Filter by name or type

- Default geometry
 - Origin
 - Top
 - Front
 - Right
- Domino
- Extrude 1
- Extrude 2**
- Fillet 1
- Fillet 2
- Fillet 3

Extrude 2

Solid Surface

New Add Remove Intersect

Faces and sketch regions to extrude

Face of Domino

Blind

Depth 2 mm

Draft

Second end position

Merge with all

Merge scope

Part 1

Final

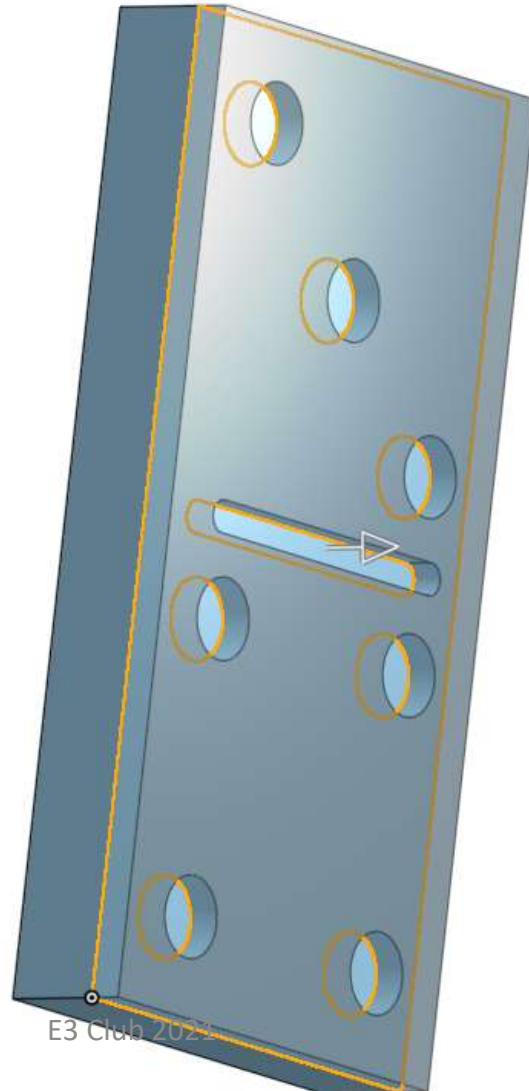



Features (10)

Filter by name or type

- Default geometry
 - Origin
 - Top
 - Front
 - Right
- Domino
- Extrude 1
- Extrude 2
- Fillet 1**
- Fillet 2
- Fillet 3

Parts (1)

- Part 1

Fillet 1

Entities to fillet

- Edge of Extrude 2
- Edge of Extrude 2
- Edge of Extrude 2

Tangent propagation

Cross section Circular

Radius 0.5 mm

Allow edge overflow

Variable fillet

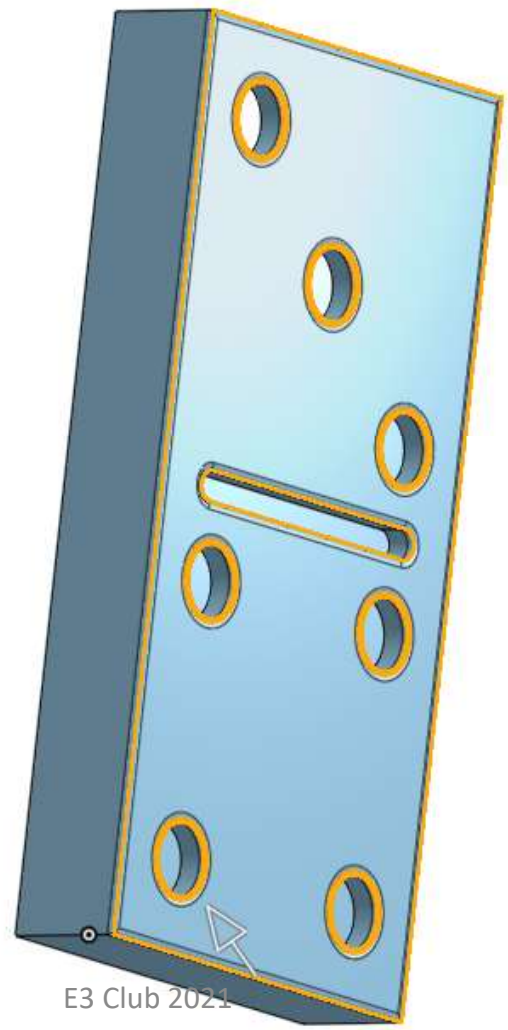



Features (10)

Filter by name or type

- Default geometry
 - Origin
 - Top
 - Front
 - Right
- Domino
- Extrude 1
- Extrude 2
- Fillet 1
- Fillet 2**
- Fillet 3

Parts (1)

- Part 1

Fillet 2

Entities to fillet

- Edge of Fillet 1
- Edge of Fillet 1
- Edge of Fillet 1

Tangent propagation

Cross section: Circular

Radius: 5 mm

Allow edge overflow

Variable fillet

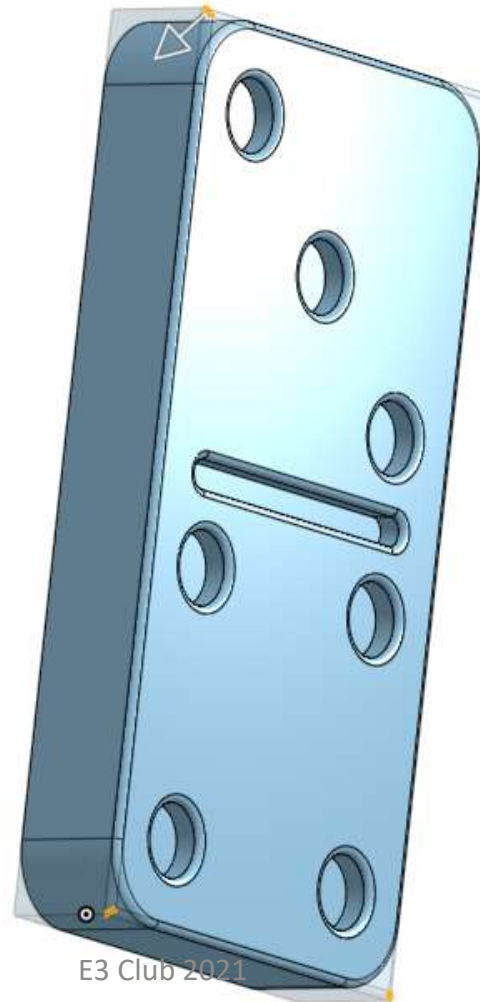

onshape 3DDOS-Domino Main

Sketch

Features (10)

- Filter by name or type
- Default geometry
 - Origin
 - Top
 - Front
 - Right
- Domino
- Extrude 1
- Extrude 2
- Fillet 1
- Fillet 2
- Fillet 3**

Parts (1)

- Part 1

Fillet 3

Entities to fillet

- Face of Extrude 1

Tangent propagation

Cross section: Circular

Radius: 1 mm

Allow edge overflow

Variable fillet

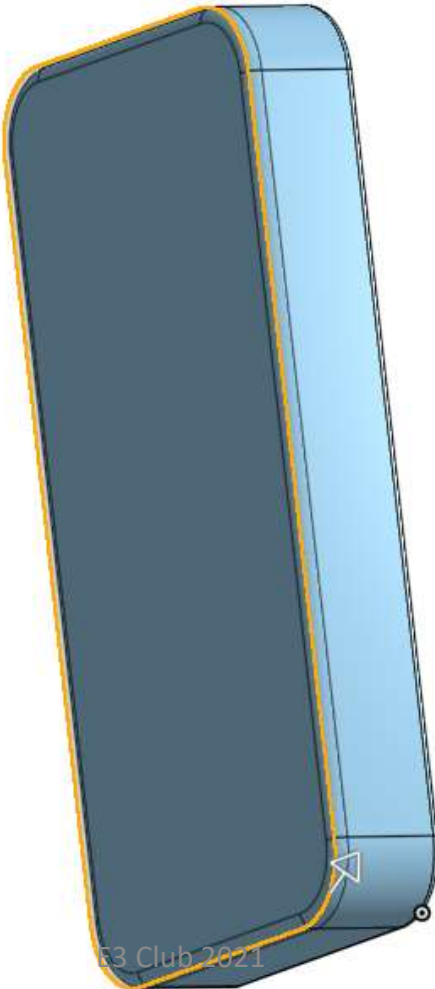

ES Club 2021

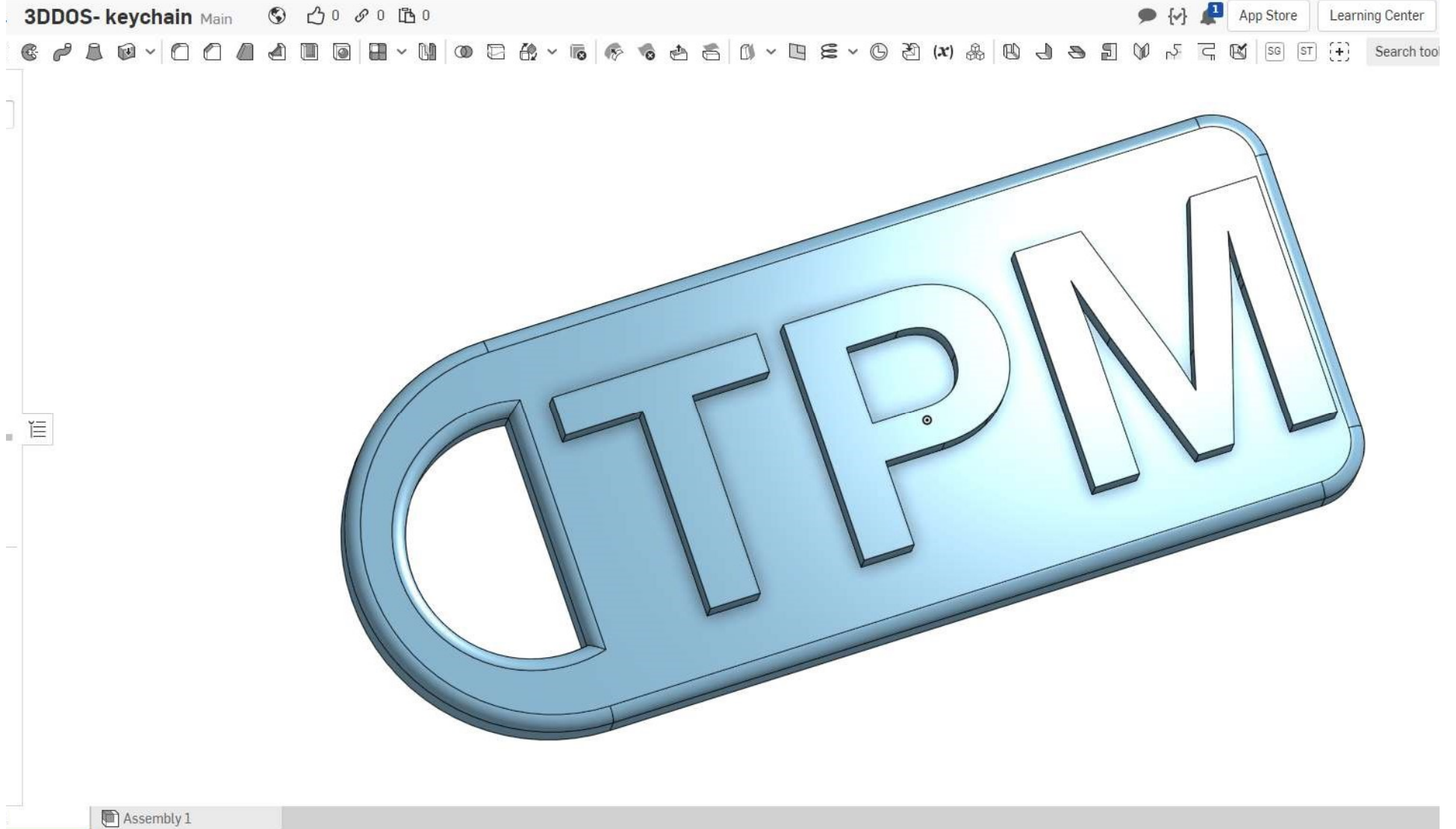

nshape 3DDOS- keychain Main



- es (11)
- Filter by name or type
- fault geometry
- Origin
- Top
- Front
- Right
- etch 1**
- trude 1
- etch 2
- trude 2
- let 1
- let 2
- amfer 1

Sketch 1

Sketch plane
Top plane

Show constraints

Show overdefined

Final

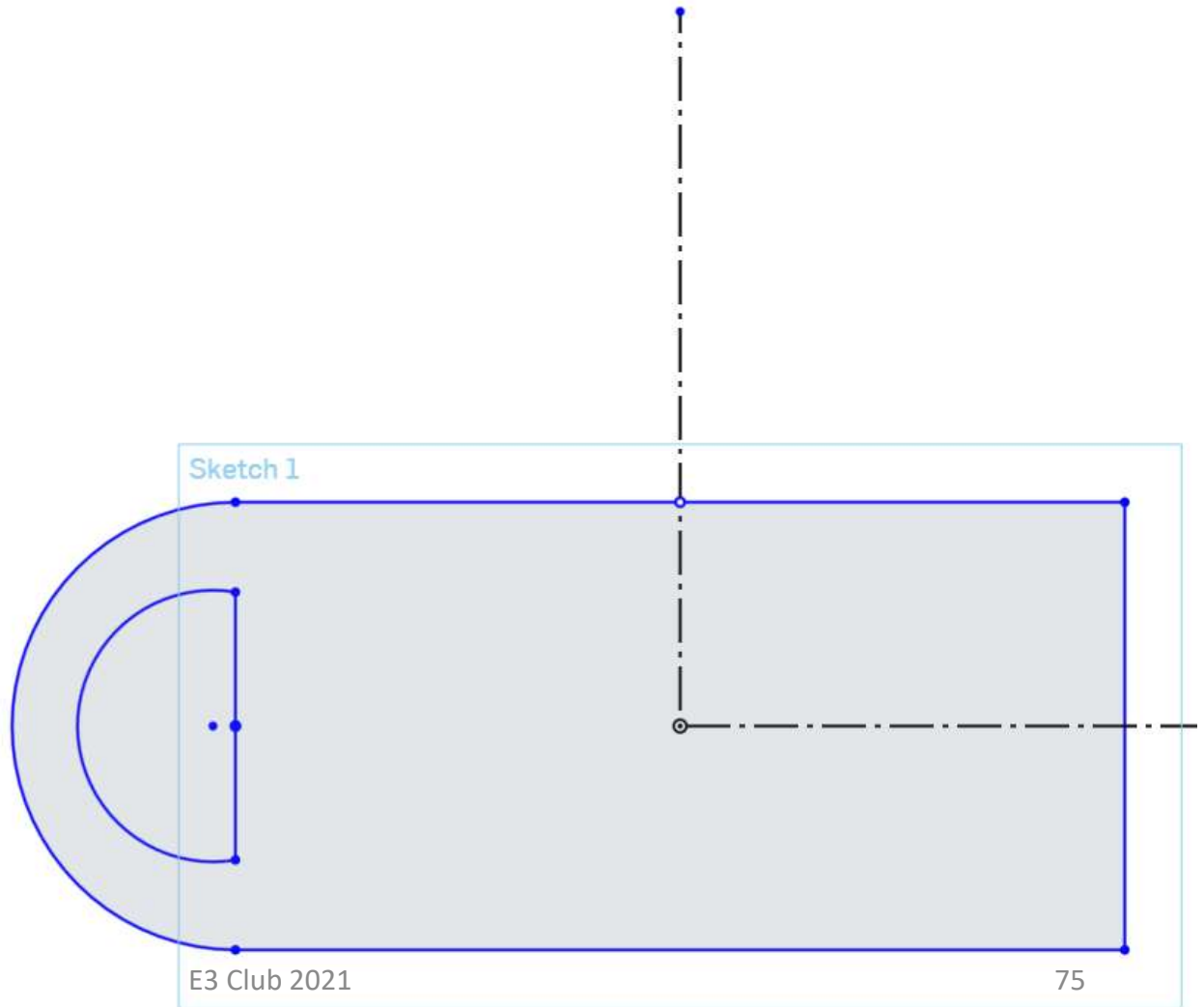

ts (0)

Features (11)

Filter by name or type

Default geometry

- Origin
- Top
- Front
- Right
- Sketch 1
- Extrude 1**
- Sketch 2
- Extrude 2
- Fillet 1
- Fillet 2
- Chamfer 1

Parts (1)

- Part 1

Extrude 1

Solid Surface

New Add Remove Intersect

Faces and sketch regions to extrude

Faces of Sketch 1

Blind

Depth 0.197 in

Draft

Second end position

Final

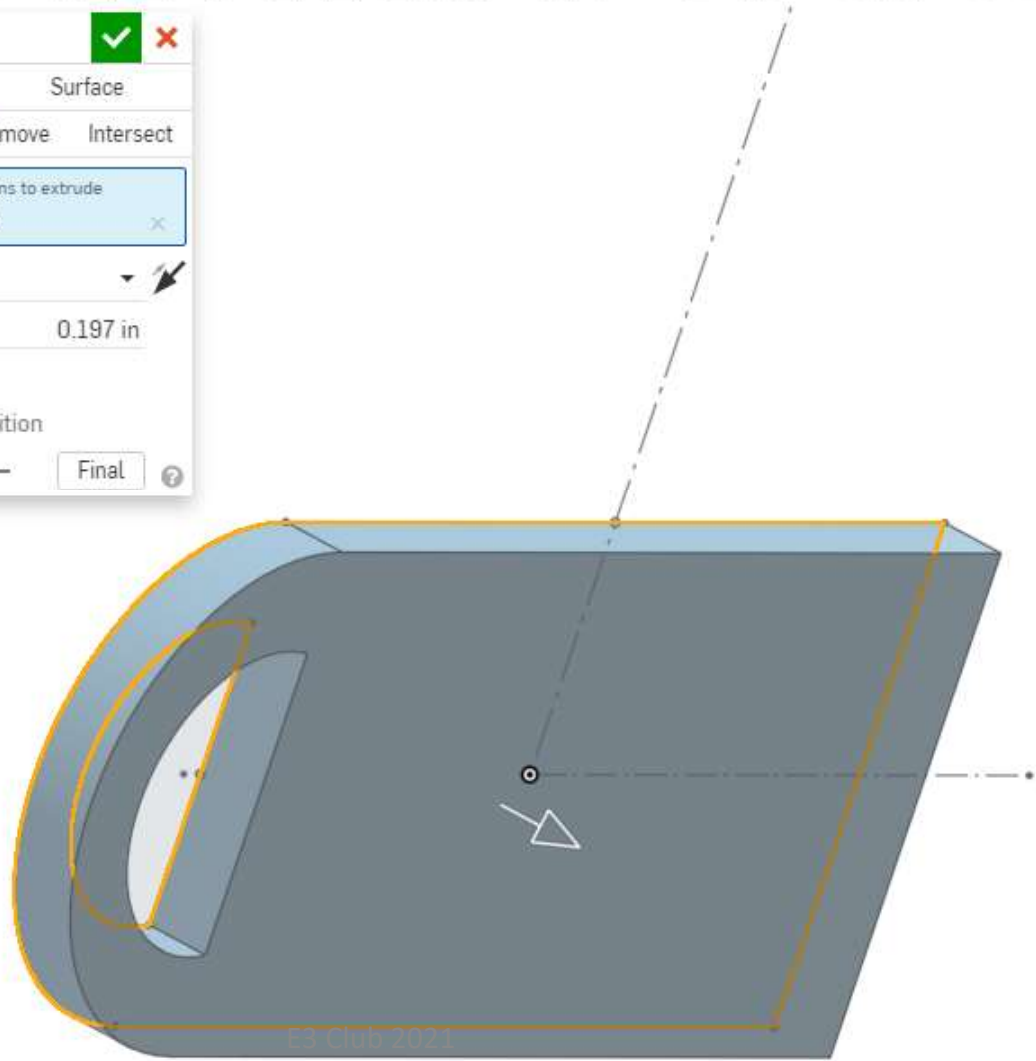



- Features (11)
- Filter by name or type
- Default geometry
 - Origin
 - Top
 - Front
 - Right
 - Sketch 1
 - Extrude 1
 - Sketch 2**
 - Extrude 2
 - Fillet 1
 - Fillet 2
 - Chamfer 1

Sketch 2

Sketch plane

Face of Extrude 1

Show constraints

Show overdefined

Final

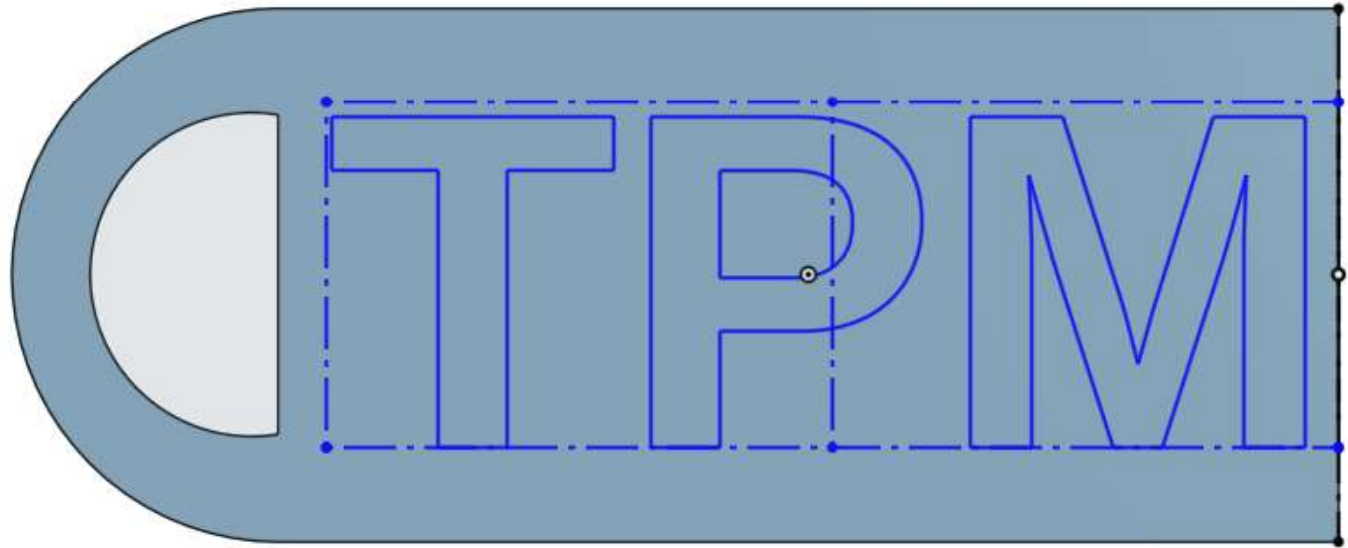

- Parts (1)
- Part 1

Exercise 3 Extrude2

onshape 3DDOS- keychain Main

Sketch

Features (11)

- Filter by name or type
- Default geometry
 - Origin
 - Top
 - Front
 - Right
- Sketch 1
- Extrude 1
- Sketch 2
- Extrude 2**
- Fillet 1
- Fillet 2
- Chamfer 1

Extrude 2

Solid Surface

New Add Remove Intersect

Faces and sketch regions to extrude

Faces of Sketch 2

Blind

Depth 0.118 in

Draft

Second end position

Merge with all

Merge scope

Part 1

Final

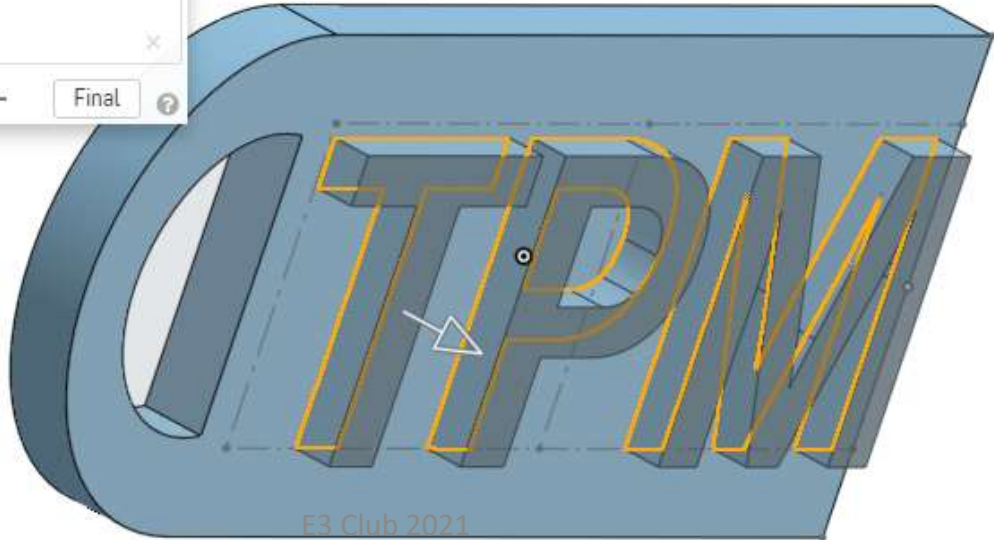

E3 Club 2021

onshape 3DDOS- keychain Main



Features (11)

- Filter by name or type
- Default geometry
 - Origin
 - Top
 - Front
 - Right
- Sketch 1
- Extrude 1
- Sketch 2
- Extrude 2
- Fillet 1
- Fillet 2
- Chamfer 1

- Parts (1)
 - Part 1





Features (11)

Filter by name or type

Default geometry

- Origin
- Top
- Front
- Right

- Sketch 1
- Extrude 1
- Sketch 2
- Extrude 2
- Fillet 1
- Fillet 2
- Chamfer 1**

Parts (1)

Part 1

Chamfer 1 ✓ ✕

Entities to chamfer:
Face of Extrude 1 ✕

Equal distance ▾

Distance 0.02 in

Tangent propagation

— [Slider] ?

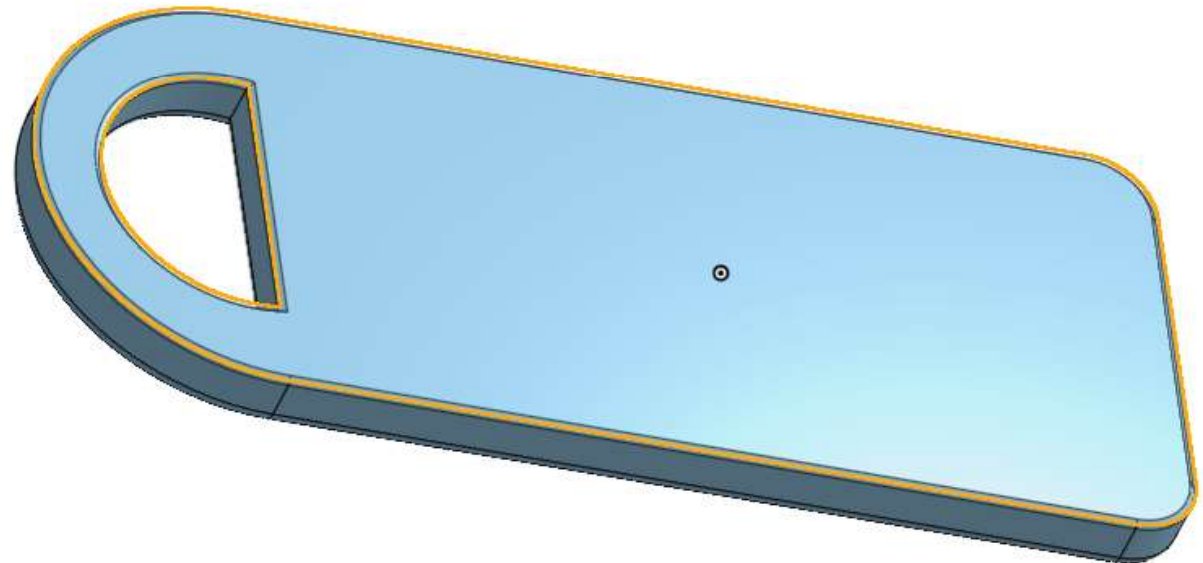



Features (11)

Filter by name or type

- Default geometry
 - Origin
 - Top
 - Front
 - Right
- Sketch 1
- Extrude 1
- Sketch 2
- Extrude 2
- Fillet 1
- Fillet 2
- Chamfer 1

Parts (1)

- Part 1

- Rename
- Properties...
- Assign material...
- Edit appearance...
- Copy...
- Create Drawing of Part 1...
- Export...**
- Hide
- Isolate...
- Make transparent...
- Add comment
- Zoom to selection
- Delete...

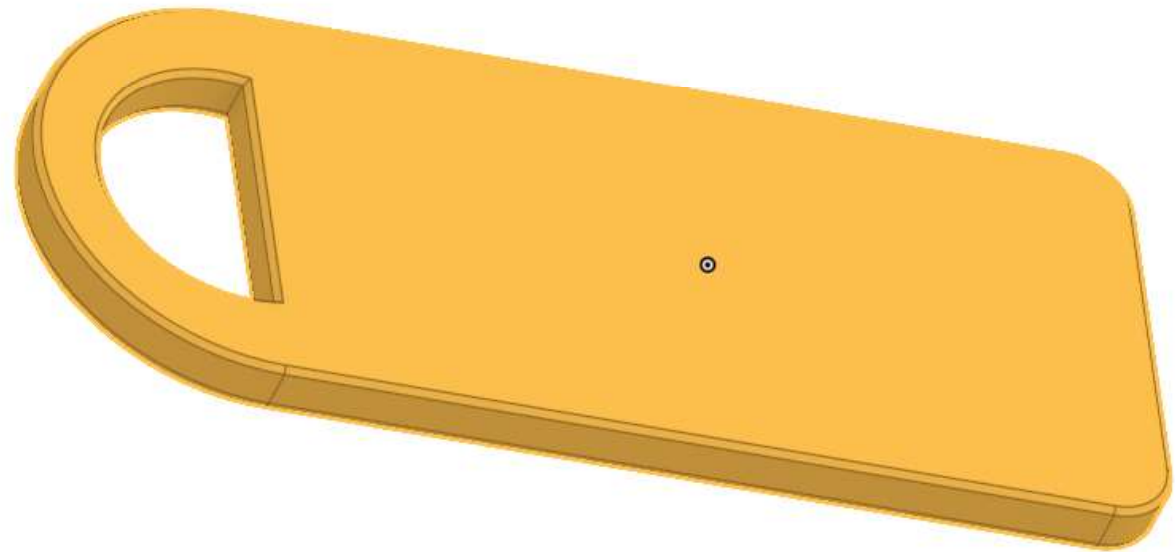

DOS_Oil Tank Main 

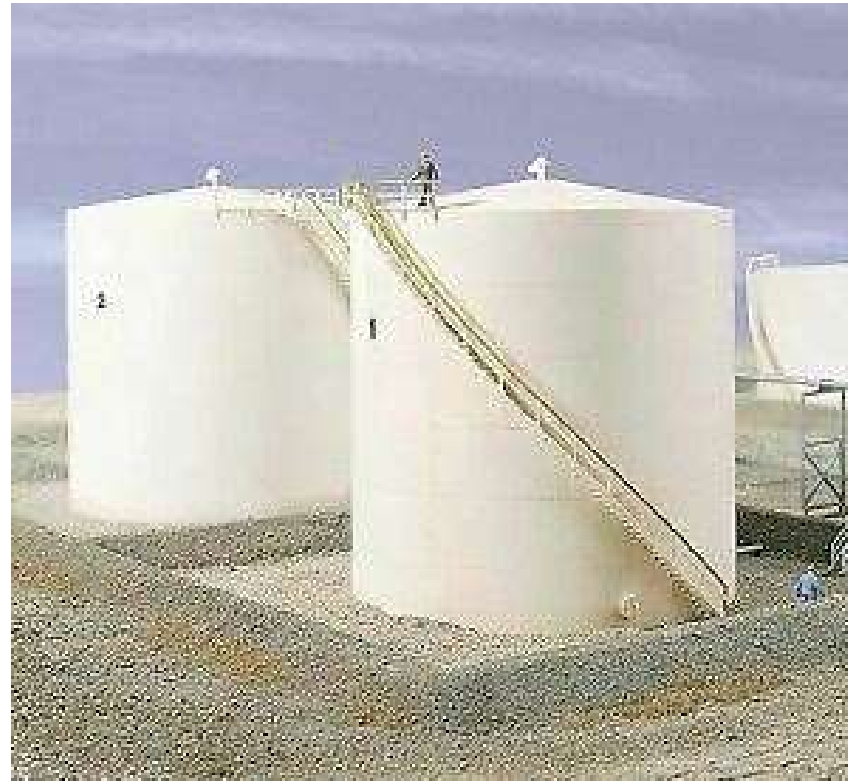
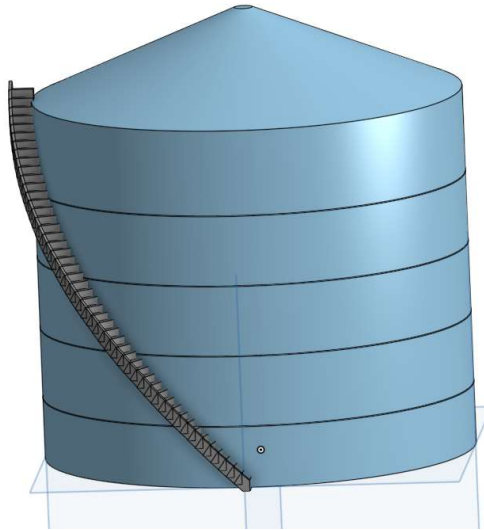

WALTHERS CORNERSTONE HO SCALE OIL STORAGE TANK TALL KIT 933-3168

This is a plastic model kit that requires assembly. Glue not included. Figures, scenic accessories, and vehicles are not included unless otherwise specified. **Dimensions: Tank: 6" Diameter x 6-1/4" Tall 15.2 x 15.9cm.** Retention Berms: 12-1/2 x 12-1/2" 31.8 x 31.8cm. A must-have for your industry scenes! Surround your Walther's Cornerstone United Petroleum Refining facility with a tank farm comprised of Tall Oil Storage Tanks and Retention Berms. You can also use them at pipeline terminals, chemical companies, corn processing facilities, ethanol plants, port facilities and at railroad yards where they're used for fuel and oil storage. Easy-to-build kit creates a tall 500,000-gallon tank, and includes a stairway molded to fit the tank body, berm crossover stairways and decals. Also included are modular retention berms which can be used to combine multiple tall or wide tanks into a complete scene.

onshape **3DDOS_Oil Tank** Main

Features (12)

- Default geometry
 - Origin
 - Top
 - Front
 - Right
- Sketch 1**
- Revolve 1
- Sketch 2
- Extrude 1
- Sketch 3
- Extrude 2
- Helix 1
- Curve pattern 1

Parts (0)

Sketch 1

- Sketch plane: Right plane
- Show constraints:
- Show overdefined:
- Final

3

Ø6

6.25

E3 Club 2021

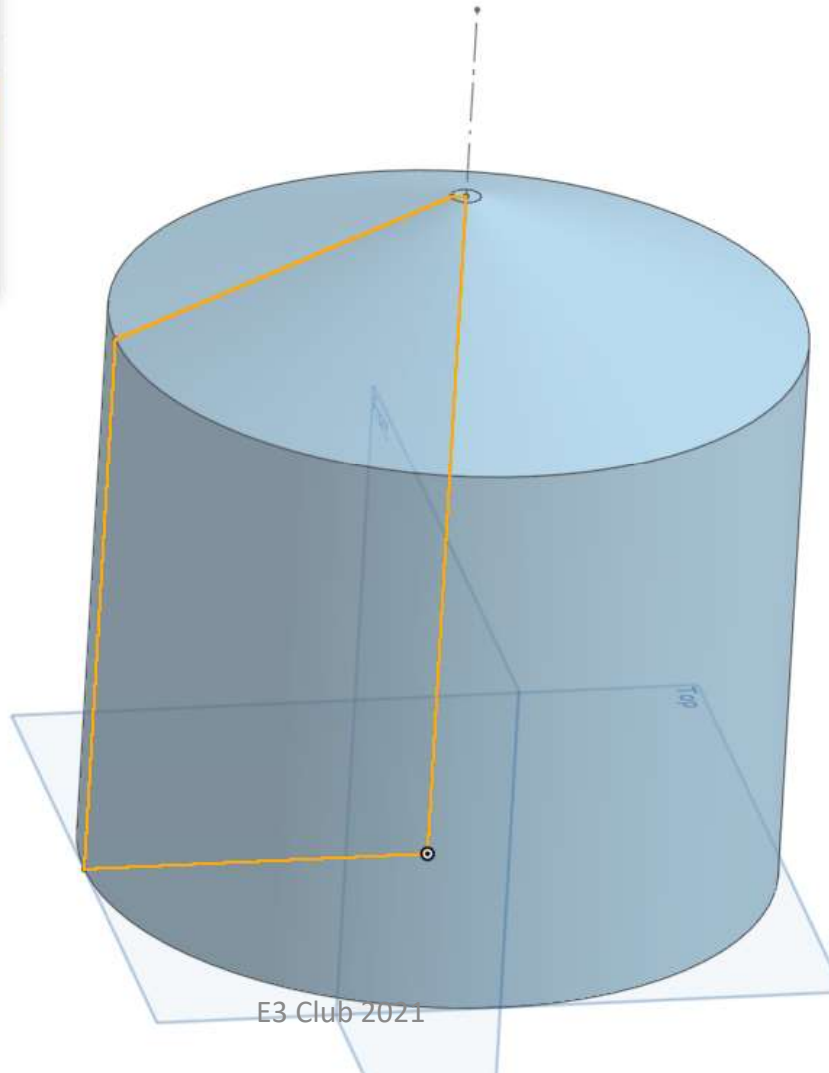
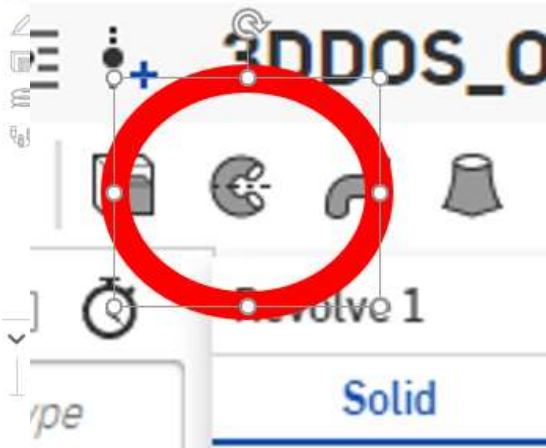
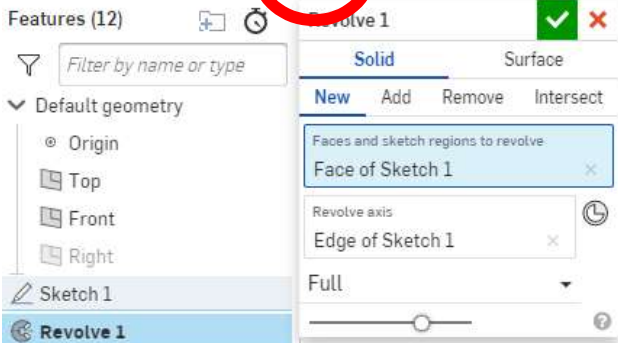



Features (12)

Filter by name or type

- Default geometry
 - Origin
 - Top
 - Front
 - Right
- Sketch 1
- Revolve 1**
- Sketch 2
- Extrude 1
- Sketch 3
- Extrude 2
- Helix 1
- Curve pattern 1

Revolve 1

Solid Surface

New Add Remove Intersect

Faces and sketch regions to revolve

Face of Sketch 1

Revolve axis

Edge of Sketch 1

Full

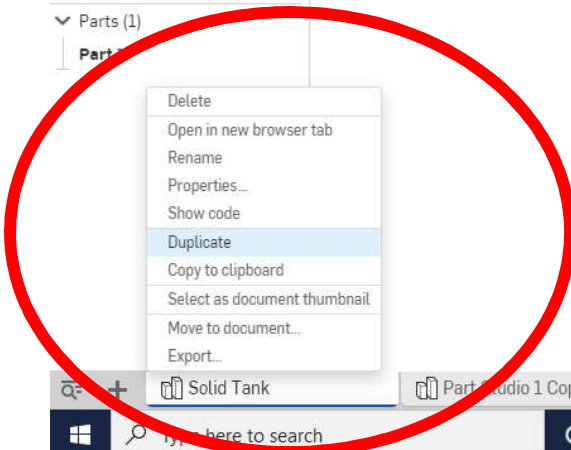
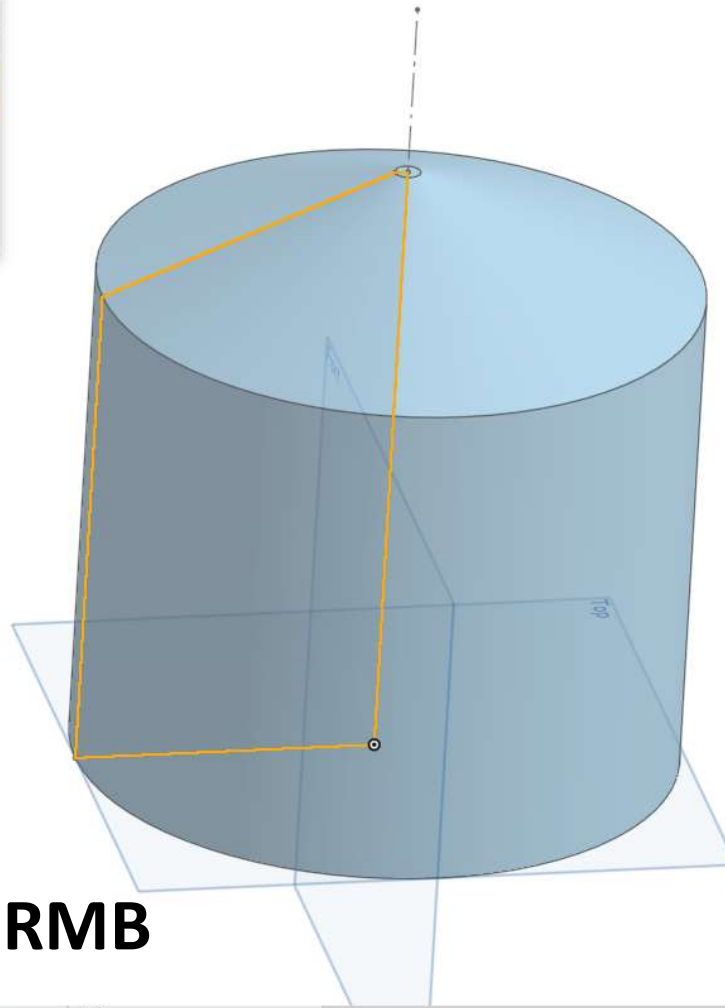

RMB

onshape 3DDOS_Oil Tank Main

Features (12)

- Filter by name or type
- Default geometry
 - Origin
 - Top
 - Front
 - Right
- Sketch 1**
- Revolve 1
- Sketch 2
- Extrude 1
- Sketch 3
- Extrude 2
- Helix 1
- Curve pattern 1

Sketch 1

- Sketch plane: Right plane
- Show constraints:
- Show overdefined:
- Final

0.99

4x

0.012

3

6.25

86

Right

Sketch 1

E3 Club 2021

onshape 3DDOS_Oil Tank Main

Features (12)

- Default geometry
 - Origin
 - Top
 - Front
 - Right
- Sketch 1**
- Revolve 1
- Sketch 2
- Extrude 1
- Sketch 3
- Extrude 2
- Helix 1
- Curve pattern 1

Parts (0)

Sketch 1

- Sketch plane: Right plane
- Show constraints:
- Show overdefined:
- Final

0.99

0.012

1x

E3 Club 2021

87

Features (12)

 *Filter by name or type*

▼ Default geometry

- Origin
-  Top
-  Front
-  Right

 Sketch 1

 Revolve 1

 **Sketch 2**



 Extrude 1

 Sketch 3

 Extrude 2

 Helix 1

 Curve pattern 1

Sketch 2  

Sketch plane

Right plane 

Show constraints

Show overdefined

Final 

▼ Parts (1)

Part 1



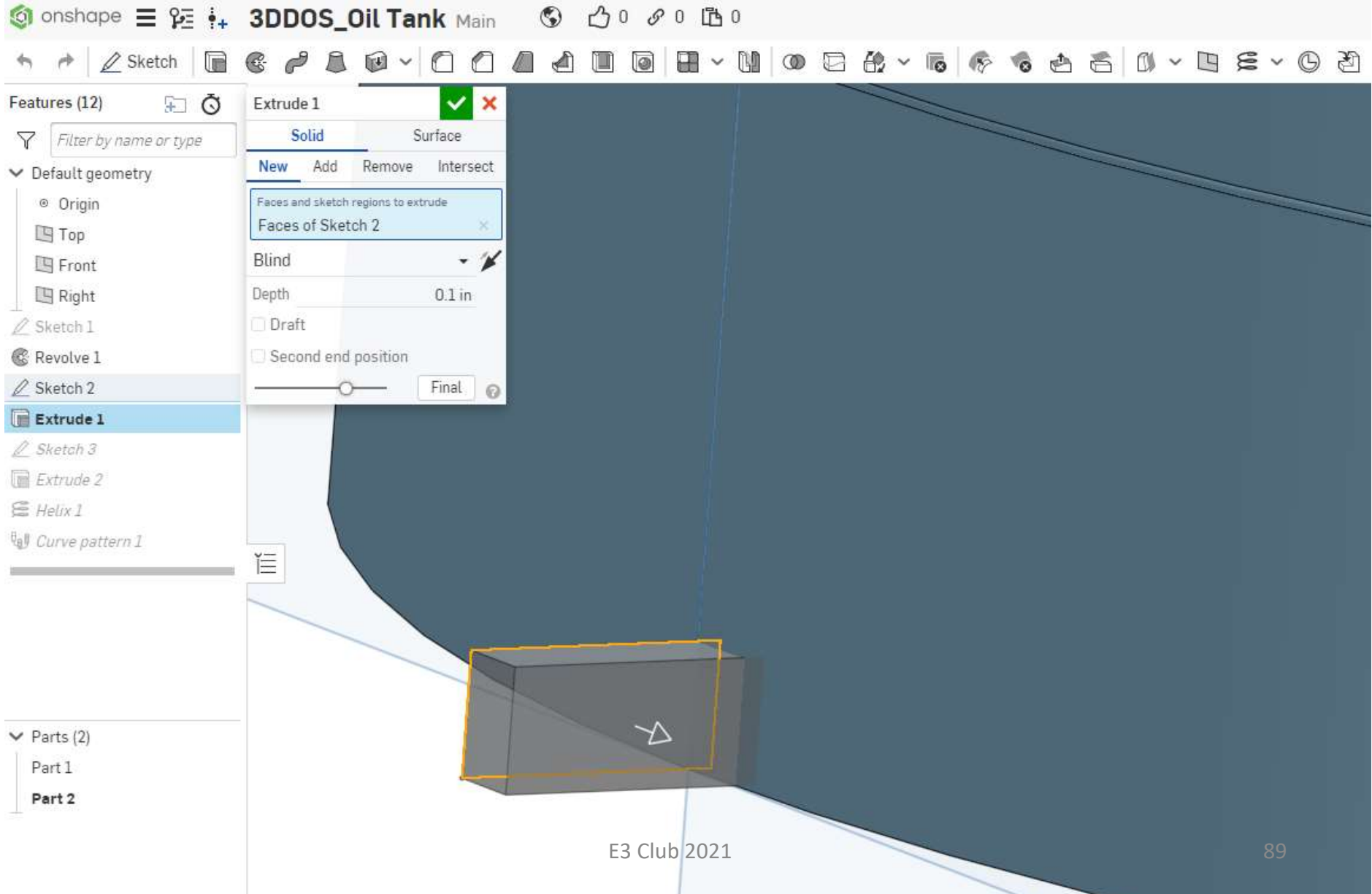

The screenshot displays the Onshape CAD interface for a file named "3DDOS_Oil Tank". The "Features" tree on the left lists 12 features, with "Extrude 1" selected. The "Extrude 1" configuration panel is open, showing the "Solid" tab. The "Faces and sketch regions to extrude" section is set to "Faces of Sketch 2". The "Depth" is set to "0.1 in". The "Blind" checkbox is checked, and the "Draft" and "Second end position" checkboxes are unchecked. The "Final" button is visible at the bottom of the panel. The main workspace shows a 3D model of a part with a rectangular feature highlighted in orange, indicating the current extrusion operation.

onshape 3DDOS_Oil Tank Main

Features (12)

Filter by name or type

Default geometry

- Origin
- Top
- Front
- Right
- Sketch 1
- Revolve 1
- Sketch 2
- Extrude 1**
- Sketch 3
- Extrude 2
- Helix 1
- Curve pattern 1

Parts (2)

- Part 1
- Part 2**

Extrude 1

Solid Surface

New Add Remove Intersect

Faces and sketch regions to extrude

Faces of Sketch 2

Blind

Depth 0.1 in

Draft

Second end position

Final

E3 Club 2021

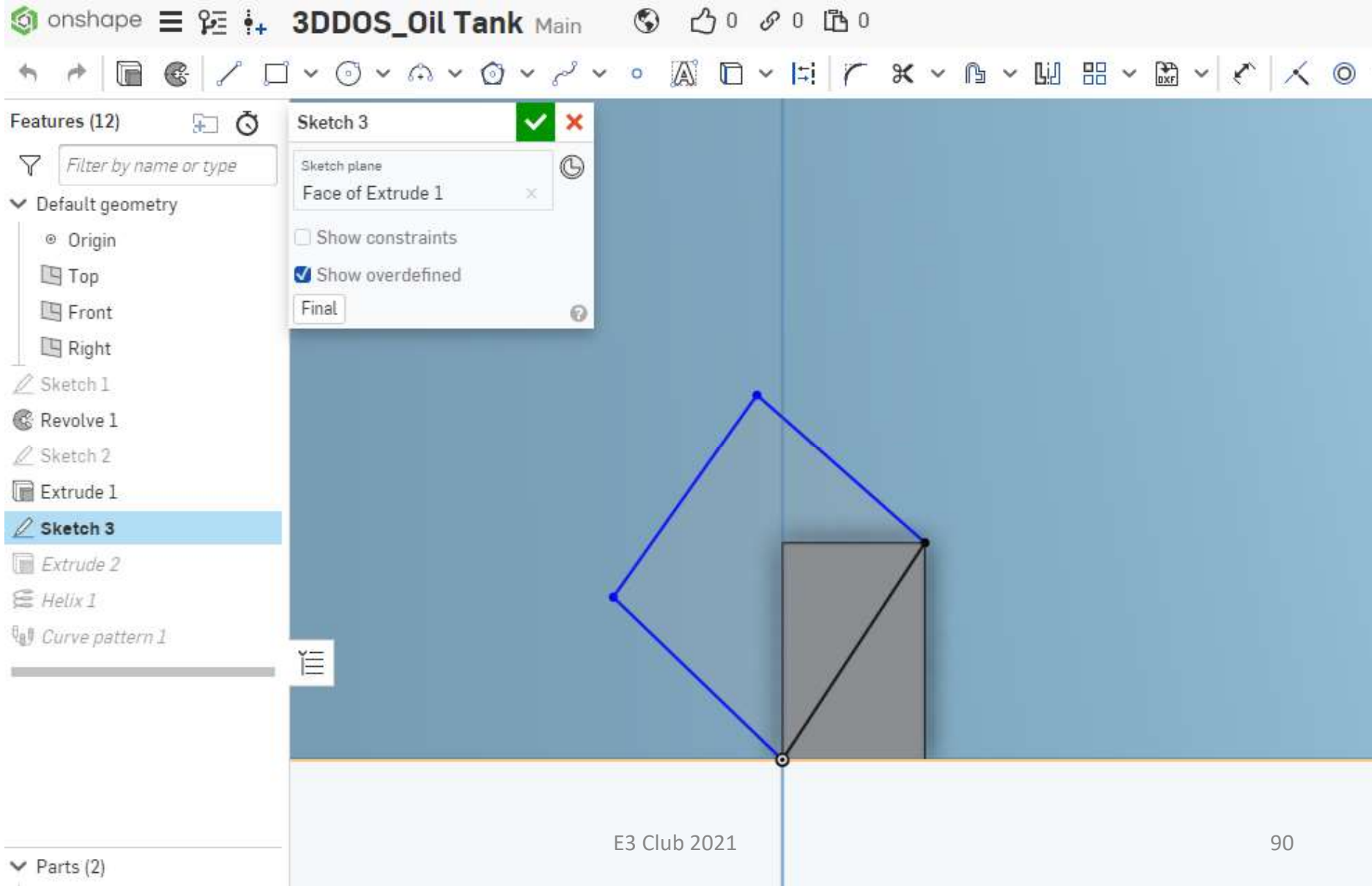

89



The screenshot shows the Onshape CAD software interface. The top bar displays the file name "3DDOS_Oil Tank" and the "Main" workspace. The left sidebar shows a list of features: "Features (12)", "Default geometry" (Origin, Top, Front, Right), "Sketch 1", "Revolve 1", "Sketch 2", "Extrude 1", "Sketch 3" (highlighted), "Extrude 2", "Helix 1", and "Curve pattern 1". The "Parts (2)" section is visible at the bottom left. The main workspace shows a 3D model of a cylindrical tank with a grey rectangular extrusion on its side. A blue sketch is being created on the side face of this extrusion. A context menu for "Sketch 3" is open, showing "Sketch plane: Face of Extrude 1", "Show constraints" (unchecked), "Show overdefined" (checked), and a "Final" button. The bottom of the interface contains the text "E3 Club 2021" and the page number "90".

Features (12)

- Filter by name or type
- Default geometry
 - Origin
 - Top
 - Front
 - Right
- Sketch 1
- Revolve 1
- Sketch 2
- Extrude 1
- Sketch 3
- Extrude 2**
- Helix 1
- Curve pattern 1

Extrude 2  

Solid Surface

New **Add** Remove Intersect

Faces and sketch regions to extrude
Faces of Sketch 3 

Blind 



Depth 0.039 in

Draft

Second end position

Merge with all

Merge scope
Part 2 

 Final 

- Parts (2)
- Part 1
- Part 2

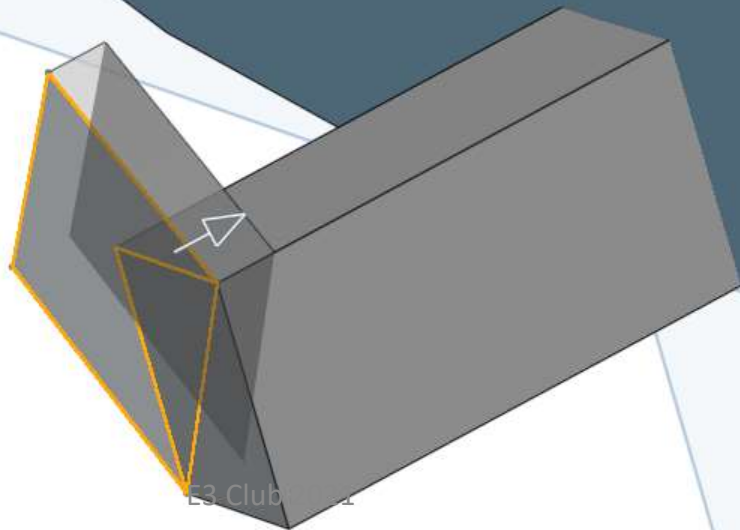

onshape 3DDOS_Oil Tank Main

Sketch

Features (12)

Filter by name or type

Default geometry

- Origin
- Top
- Front
- Right

Sketch 1

Revolve 1

Sketch 2

Extrude 1

Sketch 3

Extrude 2

Helix 1

Curve pattern 1

Parts (2)

- Part 1
- Part 2

Curves (1)

Helix 1

Turns

Conical or cylindrical face

Face of Revolve 1

Counterclockwise

Revolutions 0.25

Start angle -90 deg

Final

E3 Club 2021

92

onshape 3DDOS_Oil Tank Main

Sketch

Features (12)

Filter by name or type

Default geometry

- Origin
- Top
- Front
- Right
- Sketch 1
- Revolve 1
- Sketch 2
- Extrude 1
- Sketch 3
- Extrude 2
- Helix 1
- Curve pattern 1**

Curve pattern 1

Part pattern

New Add Remove Intersect

Entities to pattern

Part 2

Path to pattern along

Curve 1

Instance count 50

Keep orientation

Linear pattern

Circular pattern

Curve pattern

For best results ensure that the path start point and pattern seed are touching.

Circular pattern

Create multiple instances of parts, faces or features uniformly around an axis.

1. Select parts, faces or features to pattern.
2. Select the axis.
3. Specify the angle between the instances.
4. Specify the number of instances.

Parts (51)

- Part 1
- Part 2**
- Part 3
- Part 4
- Part 5
- Part 6
- Part 7
- Part 8

E3 Club 2021

93